

The Illinois Barn Owl Recovery Plan



© Richard Day/Daybreak Imagery

November 2010

State Wildlife Grant Program T-35-P-1

The Illinois Barn Owl Recovery Team:

Jeff W. Walk¹, Anne Mankowski², Terry L. Esker³, Maggie Cole³, Mark G. Alessi³

¹University of Illinois at Urbana-Champaign

²Illinois Endangered Species Protection Board

³Illinois Department of Natural Resources

Executive Summary

The barn owl, *Tyto alba*, is one of the most widely distributed species of birds, nesting on all continents (except Antarctica) and many islands. In spite of wide versatility in nesting habitats and prey selection, barn owls have become rare in the Midwestern United States. Population declines are strongly correlated with changing agricultural practices. Hay and pasture – rich foraging areas for voles (*Microtus spp.*), the preferred prey in the region – have been extensively converted to row crops which support fewer prey. Concomitantly, the replacement of open wooden barns with closed metal structures has reduced potential nesting sites. Today, barn owls are *Endangered in Illinois*, and a *Species in Greatest Need of Conservation* in the Illinois Wildlife Action Plan.

Barn owl conservation has been widely attempted, with mixed success. Nest boxes installed for barn owls are readily adopted. Releases of captive-reared barn owls have not produced clear benefits to wild populations. Managing habitat specifically for barn owls is complicated by their wide-ranging habits and low population density, although programs that increase grassland foraging habitat have benefitted barn owls. Restoring and enhancing grassland and early-successional habitats, as prescribed in the Illinois Wildlife Action Plan's *Farmland & Prairies Campaign*, will benefit barn owls and other *Species in Greatest Need of Conservation*.

Although barn owls are rare in Illinois, they remain broadly distributed with 1990-2009 nesting records from 31 counties, mostly in the southern one-half of the state. Barn owl populations are secure in Mississippi River Valley states south of Illinois, and populations in some Midwestern states (Missouri, Ohio) appear to be expanding. Though the barn owl is

unlikely to become common throughout Illinois, it is feasible to improve the status of the barn owl so that it no longer warrants listing as an Illinois *Endangered* or *Threatened* species.

We recommend the Illinois Endangered Species Protection Board evaluate the status of the barn owl and consider a change in status from *Endangered* to *Threatened* when 40 active nest sites distributed among at least 15 counties are reported within a 5-year period. A change in status from *Threatened* to recovered should be considered when 80 active nest sites distributed among at least 30 counties are reported in a 5-year period, and other threats to the population are low.

To achieve the recovery of the barn owl in Illinois, six prioritized strategies have been developed:

Deploy and monitor nest boxes within plausible nesting areas. Barn owls readily adopt nest boxes of various designs, and barn owl nests in boxes tend to be more productive than nests in natural cavities. Nest boxes have been documented to increase barn owl abundance in regions with adequate prey. Because nest boxes can be easily monitored – and barn owl nests in other situations are difficult to locate – the deployment and monitoring of nest boxes is the only known, practical proxy for assessing the status and trend of local barn owl populations. Factors to consider when deploying nest boxes include regional climate suitability, nearby foraging habitat, proximity to known nesting barn owls, ease of monitoring/maintenance, and potential for disruption during nesting.

Do not interfere with young barn owls during fledging. Because many barn owl nests are discovered when the nest is damaged or disturbed, young barn owls are frequently captured and taken to wildlife rehabilitators. Bringing birds into captivity should be done as a last resort, as rehabilitated birds have lower survival than wild birds. Unless a young barn owl is seriously

injured, biologists should either not interfere, or move the bird(s) to a very close safe location, such as a nest box. When their nest has been destroyed or disturbed, adult barn owls will typically resume care of their young that have been moved into a nest box.

Expand dedicated grassland conservation areas. Barn owls have colonized some grassland conservation areas in Illinois, so expanding grassland sites and creating additional sites dedicated to conserving grassland wildlife are likely to benefit barn owls and other *Species in Greatest Need of Conservation*. Grassland wildlife are among the most imperiled in the state, making the need for dedicated grassland conservation areas particularly acute.

Encourage land use practices that support populations of voles (*Microtus spp.*) and other small mammals. Perennial grassy habitats, like hay fields, pastures, wet meadows, and Conservation Reserve Program grasslands, all support greater populations of small mammals, especially voles, than do row crops. A low concentration of suitable foraging habitat is probably the ultimate factor causing the low abundance of barn owls in Illinois and the Midwest.

Build Public Awareness of Barn Owls & Support for Barn Owl Conservation. Educational materials and outreach efforts are important to several aspects of barn owl recovery. Barn owls probably occur more often in Illinois than records indicate, so encouraging the public (especially private land owners) to report barn owls will help monitor the barn owl's true distribution in Illinois. The cooperation of private landowners will be essential for deploying and monitoring nest boxes, and enhancing grassland habitat.

Research of Barn Owl Ecology & Behavior. Barn owl populations are poorly monitored, with nest box monitoring the only currently available, practical alternative. It is unknown whether broadcasts of barn owl sounds would enhance detections of barn owls.

Similar ‘playbacks’ are key components of monitoring programs for other secretive birds. Areas of apparently suitable habitat occur in Illinois, but remain unoccupied for unknown reasons.

Barn owls can quickly colonize areas of suitable habitat, readily adopt nest boxes, are tolerant of human presence, and are capable of high reproductive output and rapid population growth. There are some indications barn owl populations in the Midwest are slightly expanding. Implementation of this recovery plan is expected improve the status of the barn owl so that it no longer warrants listing as an Illinois *Endangered* or *Threatened* species.

Table of Contents

Executive Summary.....	2
Acknowledgements	10
Introduction.....	11
Taxonomy.....	12
Description	13
Distribution & Status.....	15
Global.....	15
North America.....	16
Illinois.....	17
Ecology of Barn Owls.....	20
Life History.....	20
Habitat.....	24
Metapopulation Dynamics.....	25
Interspecific Interactions.....	26
Conservation & Management of Barn Owls.....	27
Reasons for Status.....	27
Conservation Measures.....	31
Recovery Potential.....	33
Joint Recovery.....	34
Ecosystem Restoration & Management.....	34
Species in Greatest Need of Conservation.....	35
Recovery.....	36

Definitions.....	36
Objectives & Criteria.....	37
Prioritized Strategies.....	40
Monitoring & Evaluation.....	46
Recovery Plan Review & Revision.....	53
Literature Cited & Data Sources.....	56
Appendix I.....	65
Appendix II.....	67

List of Figures & Tables

Fig. 1. An adult barn owl, *Tyto alba*..... 14

Fig. 2. World distribution of barn owls..... 15

Fig. 3. Distribution of the barn owl in North America..... 17

Fig. 4. Illinois counties with records of barn owls, 1990-2009..... 19

Fig. 5. Number of barn owl records in Illinois from four sources, 1975-2009:
 Element Occurrence Records, the Illinois Ornithological Records Committee,
 Spring Bird Counts, Christmas Bird Counts, and reports in Meadowlark:
 A Journal of Illinois Birds..... 20

Fig. 6. Young barn owls in a tree cavity. Birds within a brood may vary in age
 by up to 14 days..... 22

Fig. 7. Limits of the area within which five captive-reared barn owls dispersed from
 northeastern Illinois, October 2009 to January 2010..... 24

Fig. 8. Counties with barn owl nest records 1990-2009 (circles), relative to the
 percentage of each county enrolled in the Conservation Reserve Program... 29

Fig. 9. A recommended design for a barn owl box, installed within a structure, with
 an opening directly to the structure’s exterior. The barn owl on the Frontispiece
 utilized a box of this design..... 41

Fig. A1. Mean daily January temperature (°F) in Illinois, 1971-2000. Conditions in northern
 Illinois likely place barn owls under high thermal stress and prolonged periods of snow
 cover make foraging more difficult for barn owls. Conditions in far southern Illinois
 likely cause low thermal stress, and snow cover seldom hinders
 foraging..... 69

Fig. A2. An index of foraging habitat availability in Illinois counties in 2008,
 sorted by quartiles. The 25% most suitable counties have 7-15% foraging habitat.
 The 25% least suitable of counties have <3% foraging habitat..... 70

Table 1. Number of nest records and number of counties with nest records of barn owls
 over the preceding three 5-year intervals, as reported to the Illinois Department
 of Natural Resources' Biotics 4 database. At least 40 nest records from 15 counties
 in a 5-year interval are necessary to prompt a review of the barn owl's status in Illinois.
 39

Table 2. Suggested annual schedule for barn owl recovery actions..... 53

Acknowledgements

The Illinois Barn Owl Recovery Plan was made possible by the collaboration of the Illinois Department of Natural Resources, Illinois Endangered Species Protection Board, and U. S. Fish & Wildlife Service. Bob Bluett (Illinois Department of Natural Resources), Jeff Hoover (Illinois Natural History Survey), Scott Meister, and Dan Thompson (DuPage County Forest Preserve District) provided helpful reviews of the draft recovery plan. Barn owl records from the Biotics 4 database were provided by Tara Kienenger (Illinois Department of Natural Resources). Photographs of barn owls in this document were provided by Richard and Susan Day/Daybreak Imagery. Funding for the Illinois Barn Owl Recovery Plan was provided by the State Wildlife Grant Program, Project T-35-P-1.

Introduction

The barn owl, *Tyto alba*, is one of the most widely distributed species of birds, nesting on all continents (except Antarctica) and many islands. Because barn owls are tolerant of human activity and readily nest in barns and other structures, they are likely the most familiar owl in the world. Their whitish plumage and distinctive heart-shaped facial ruffs give barn owls a striking, ghost-like appearance. Barn owls are well-adapted to catching prey (typically small mammals) at night. Barn owls have excellent low-light vision, their flight is nearly completely silent, and they have the ability to locate and capture prey in total darkness with their acute hearing. Barn owls are tremendous dispersers (often hundreds of km), and have high reproductive rates, enabling them to colonize and quickly populate regions with suitable habitat.

In spite of wide versatility in nesting habitats and prey selection, barn owls have become rare in portions of Europe and North America. Though barn owl populations, like most nocturnal birds, are difficult to monitor, the decline of barn owls in the Midwestern United States since the early 1900s has been well-documented. The decline is most strongly correlated with changing agricultural practices. Hay and pasture – rich foraging areas for voles (*Microtus spp.*), the preferred prey in the region – have been extensively converted to row crop agriculture which supports few prey. Concomitantly, the replacement of open wooden barns with closed metal structures has reduced potential nesting sites. Today, barn owls are *Endangered in Illinois*, and thus identified as a *Species in Greatest Need of Conservation* in the Illinois Wildlife Action Plan.

Barn owl conservation has been widely attempted, with mixed success. Nest boxes installed for barn owls are readily adopted. Where prey are abundant, nest boxes have increased barn owl populations. Numerous programs have released thousands of owls, without clear

benefits to wild populations. Managing habitat specifically for barn owls is complicated by their wide-ranging habits and low population density, although programs that increase grassland foraging habitat, like the U.S. Department of Agriculture's Conservation Reserve Program, have benefitted barn owls. Barn owls have also colonized some grassland conservation areas in Illinois. Restoring and enhancing grassland and early-successional habitats, as prescribed in the Illinois Wildlife Action Plan's *Farmland & Prairies Campaign*, will benefit barn owls and many other *Species in Greatest Need of Conservation*.

Our objective is to set forth a plan that will increase the abundance of barn owls and better document the status of barn owls in Illinois, so that listing as *Threatened* or *Endangered* in the State is no longer necessary for the species' conservation.

Taxonomy

The barn owl, *Tyto alba*, is a highly-variable cosmopolitan species. Older North American references sometimes used the scientific name *Tyto perlata* (e.g., Ridgway 1914), and the names "common barn-owl" and "common barn owl" are still widely used. All owls of the genus *Tyto* are occasionally called 'monkey-faced owls' because of their distinctive facial discs.

Within the order Strigiformes (owls), barn owls are classified in the family Tytonidae, which includes the sooty-owls, grass-owls, bay-owls, masked owls, and typical barn owls. Bruce (1999) describes 14 species in the genus *Tyto*. More than 30 subspecies of the barn owl (*Tyto alba*) have been described from continents and island groups around the world (Dickinson 2003), with distinctive sizes, proportions, plumage colorations, and feathering patterns on the tarsi (legs). The barn owl subspecies *Tyto alba pranticola* is the only taxon of the family Tytonidae

found in continental North America. Barn owl fossils from the Quaternary (2-2.5 million years ago) have been reported from Arizona, California, Florida, New Mexico, and Texas, as well as South America and Europe (Olson 1985).

Description

The barn owl is a medium-sized owl with whitish plumage and a distinctive heart-shaped facial ruff (Fig. 1). Males and females superficially appear similar, though females are larger on average than males (total length of 33-40 cm for females, 32-39 cm for males; mass of females 420-700g and 400-560g for males, Marti 1990). Barn owls appear big-headed, particularly in flight, have dark eyes, and lack ear tufts. Their long legs are sparsely feathered to the toes, and extend beyond their short, square tail in flight. Barn owls have long, rounded wings and their flight is slow, buoyant, and exceptionally quiet. The upper parts of barn owls are tawny-colored, marked with black, white and gray. The face and underwings are white. The underside plumage of barn owls is variable, with females typically having more buff coloring and black spotting, whereas some males are nearly completely white (Marti et al. 2005).

The vocalizations of barn owls have only been studied in detail in Europe (subspecies *T. a. alba* and *T. a. guttata*). Outside of the nesting season, barn owls apparently vocalize infrequently and give fewer types of vocalizations than during the nesting season. Their best-known call is a long, drawn-out scream that is most commonly given by males in flight near the nest. It is not clear whether this is a territorial call or a contact call. Variations of the scream are given as distress calls when threatened, and warning calls when their nest is approached. Mated pairs purr to one another, by males inviting females to inspect nest sites, and by females begging

for food. Nestlings hiss when humans or predators approach nests. Other sounds include snores, twitters, greeting and mobbing calls, as well as bill-snapping and wing-clapping in flight (Bühler and Epple 1980, Bunn et al. 1982).



Fig. 1. An adult barn owl, Tyto alba. © Richard Day/Daybreak Imagery.

Distribution & Status

Global. The barn owl has among the broadest distribution of any bird, found on six continents (absent from Antarctica) and islands around the world (Fig. 2). Barn owls occur in open habitats in tropical and temperate zones – they are not found in polar, alpine, or heavily forested areas. The density of barn owls is highly variable across their range. They are locally abundant in some places, and sparsely distributed over other large geographic regions. NatureServe (2009) has assigned the barn owl a global conservation rank of G5 (globally secure), the lowest priority ranking.

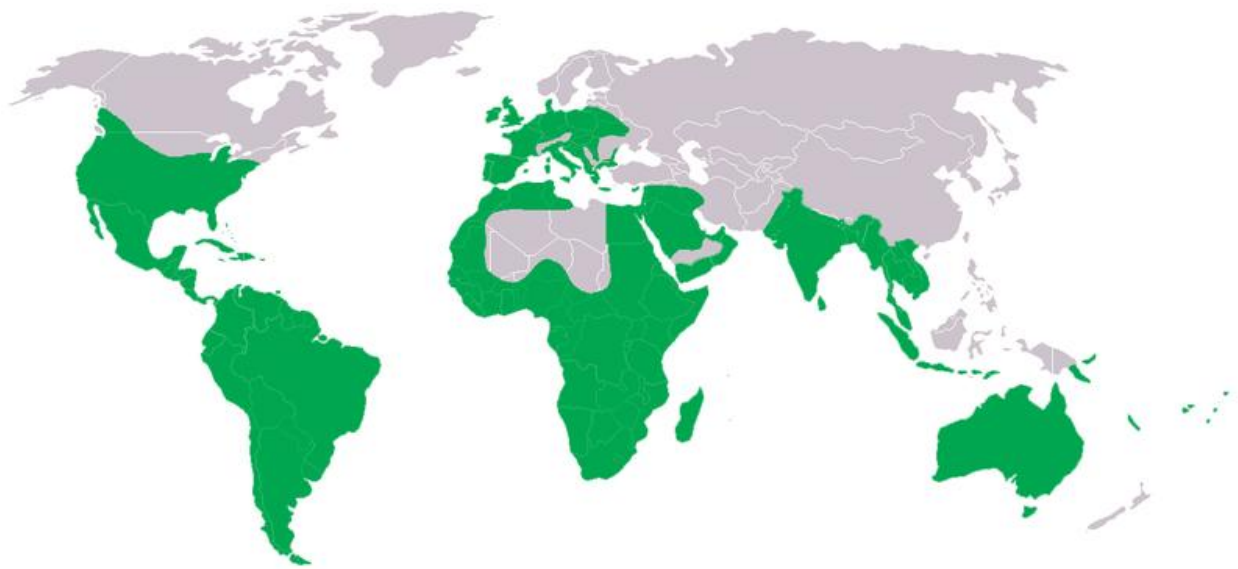

Fig. 2. World distribution of barn owls (green shading; map by Achim Raschka).

North America. Barn owls are endangered in Canada, and occur near the southern border at Vancouver Island, coastal portions of southern British Columbia, and the Niagara Peninsula of Ontario. Barn owls are widespread across the continental United States, southward through Mexico, Central America, and the Caribbean (Fig. 3). Because barn owls are poorly insulated and adapted to warmer climates, winter weather likely limits the barn owl's northern range in the northern Great Plains, Great Lakes region, and New England.

Barn owl population trends are not well-documented, because their nocturnal and secretive behaviors make them difficult to survey. However, the most severe declines have been in the Midwest (Stewart 1980, Mumford and Keller 1984, Colvin et al. 1984, Colvin 1985). Forest clearing in the upper Midwest in the 19th century created suitable habitat, and barn owls appear to have advanced farther northward than they previously occurred, reaching peak abundance in the 1920s (Colvin 1985). Changes in agricultural practices that reduced prey populations have been implicated in the subsequent decline in abundance of barn owls in the Midwest. Specifically, the shift from small-field diversified farming practices, including perennial grasslands for haying and grazing, to large-field annual row cropping reduced the abundance of small mammals across large portions of the Midwestern landscape. At present, barn owls are rare in the Midwest, and listed as an endangered species in Illinois, Iowa, Michigan, and Wisconsin, threatened in Ohio, and "special concern" in Minnesota, Nebraska, South Dakota and North Dakota. Barn owls were delisted as an endangered species in Missouri in 2008.



Fig. 3. Distribution of the barn owl in North America (purple shading; map by NatureServe).

Illinois. The barn owl is *Endangered in Illinois*, and among the least-reported resident birds in the state. For the 26-year period from 1984 through 2009, the Illinois Department of Natural Resources' Biotics 4 database for tracking Element Occurrence Records of threatened and endangered species contains 47 records of barn owls from 28 counties. The Illinois Breeding Bird Atlas (Kleen et al. 2004), based on field work conducted from 1986-1991, located barn owls in four blocks out of 1,286 sampled. Barn owls were reported on Christmas Bird Counts in Illinois in 13 of 29 years (20 out of 1,386 counts) from 1981-82 to 2008-09, at the rate of about 1 bird per 3,000 hours of search effort. Similarly, barn owls were located on Spring

Bird Counts in 17 of 34 years from 1975-2008, at the rate of about 1 bird per 2,400 hours of search effort.

The Illinois Ornithological Records Committee requests documentation for all barn owl reports, but has reviewed just 12 records since 1989. Self-reported observations from birders, published in the quarterly “Field Notes” of the *Meadowlark: A Journal of Illinois Birds*, includes 113 observations from 1991 to 2008 (Volume 1, Issue 1 through Volume 18, Issue 2), some of which are redundant reports of birds counted from Spring Bird Counts, Christmas Bird Counts, and Element Occurrence Records. Because of the documentation required, Element Occurrence Records and observations reviewed by the Illinois Ornithological Records Committee are likely the most credible.

Over the past 20 years (1990-2009), barn owls have been reported from 46 counties, with nesting records from 31 counties (Fig. 4). Most of these records come from counties in the southern one-half of the state. Although it is not possible to adjust all sources for search effort, there is a trend for the number of reports to increase over time, with nearly twice as many reports in the 2000s decade compared to the 1990s (Fig. 5), suggesting a modest rebound in barn owl abundance may be occurring.

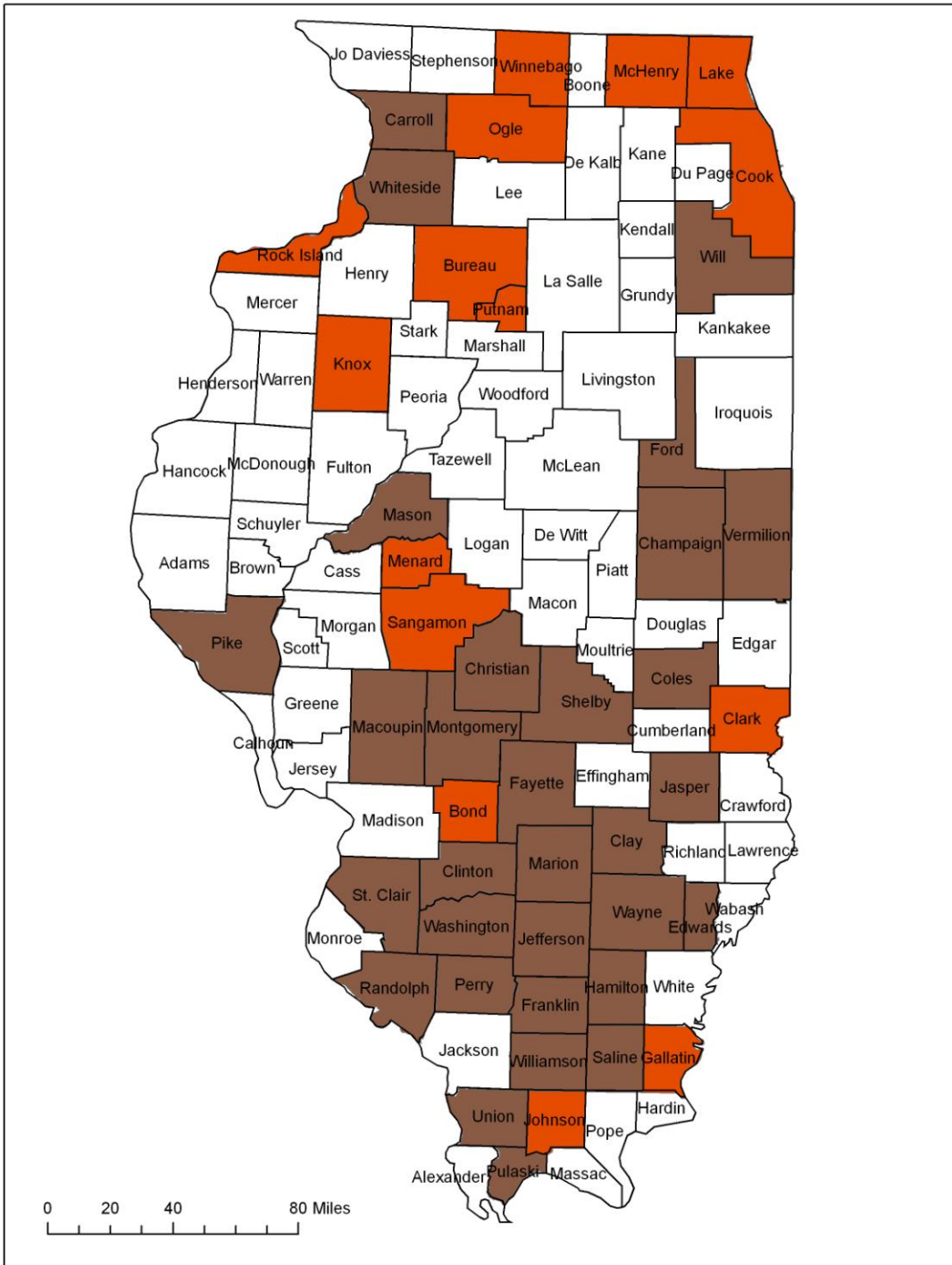

Fig. 4. Illinois counties with records of barn owls, 1990-2009. Brown shading indicates nesting records; other records are shown in orange. Compiled from various sources.

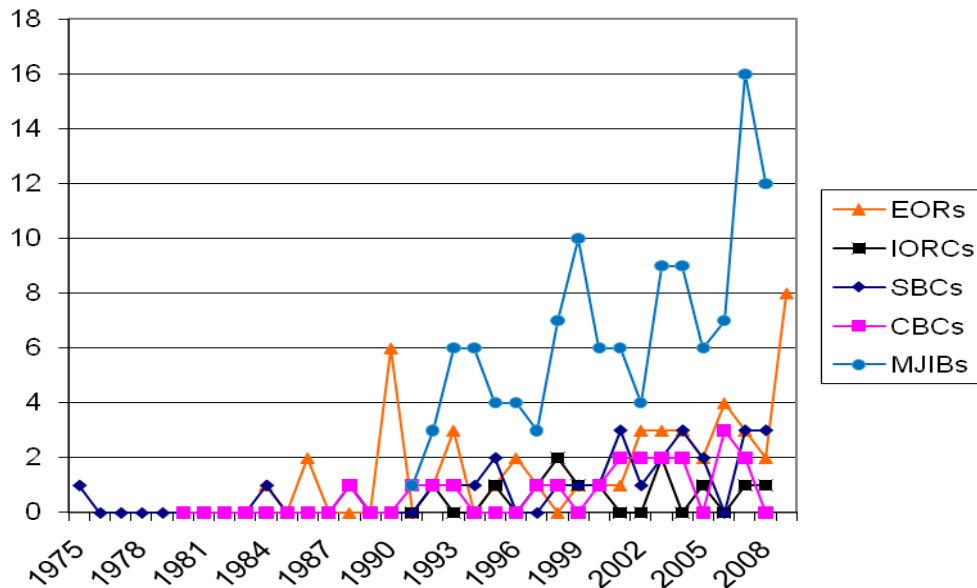

Fig. 5. Number of barn owl records in Illinois from four sources, 1975-2009: Element Occurrence Records (EORs), the Illinois Ornithological Records Committee (IORCs), Spring Bird Counts (SBCs), Christmas Bird Counts (CBCs), and reports in Meadowlark: A Journal of Illinois Birds (MJIBs).

Ecology of Barn Owls

Life History. The basic life history needs of barn owls are a supply of available prey near suitable nest sites in a relatively mild climate. Small mammals are the primary prey of barn owls, making up 74-100% of the food items found in 52 studies (Taylor 1994). Voles (*Microtus spp.*) are important prey in much of North America, though any small mammal may be taken if available (Marti et al. 2005). Barn owls hunt on the wing at night, using low-light vision and acute hearing to locate prey. Because their wings are large relative to their mass (low wing loading), barn owls are capable of low speed flight and carrying relatively heavy prey items.

Barn owls are highly adaptable to potential nest sites, and are broadly tolerant of human activity. Barns, grain bins, silos, belfries, nest boxes, and a variety of other human structures may all be used for nesting, in addition to natural nest sites such as tree cavities and dens on cliffs and bluffs. Because the basic conditions of ample prey, suitable nest sites, and mild climate can be met under a variety of circumstances, the barn owl is one of the mostly widely distributed birds in the world.

Unlike most other species of owls, barn owls have high annual mortality, and high reproductive output. The average life span of barn owls is <2 years (1.4 years, Stewart 1952; 1.7 years, Keran 1981), and first-year mortality normally is >65% in north temperate regions (Marti et al. 2005). Marti (1997) found 85% of adults only survived a single breeding season. To offset high mortality, wild barn owls may begin nesting when they are as young as 7 months (Muller 1981, Marti 1997), and are capable of producing >2 broods in a nesting season (although second and third broods are more common in tropical regions; Marti et al. 2005). In Illinois, barn owls hatched five clutches and fledged 15 young from one nest box in a 23-month period (Walk et al. 1999).

In the Midwest, the peak of nest initiation likely occurs from March-May (Hands et al. 1989, Marti et al. 2005). Clutches average 5-7 eggs in most studies (see Marti et al. 2005). Males bring food to females during the 29-34 day incubation period. Because females begin incubation with the first egg laid, and lay subsequent eggs every 2-3 days, the young hatch asynchronously and nestlings within a clutch often vary in age by 10-14 days (Fig. 6). Both parents bring food to the nest after hatching (though only the female actually feeds the young). At hatching, barn owl chicks are naked, with closed eyes, and are completely dependent on their parents for food and thermoregulation. Young barn owls grow rapidly, surpassing the weight of

adults by about 4 weeks of age, and then lose weight prior to fledging. About 2 weeks after hatching, the young are capable of walking, standing upright, and swallowing whole mice. Adult plumage begins to grow at about day 35 when young barn owls are at their peak mass, the first flight occurs at about day 55, and young are independent of adults after ~80 days. When barn owls are double-brooded, females may start laying their second clutch 75-80 days after initiating their first nest (Marti et al. 2005). Young barn owls from the first brood may still be in the nest when the female begins incubating the second clutch.



Fig. 6. Young barn owls in a tree cavity. Birds within a brood may vary in age by up to 14 days. © Todd Fink/Daybreak Imagery.

In their first autumn, young barn owls disperse in all directions up to 1,900 km from their nest site (Stewart 1952, Soucy 1980, Marti 1999). Five captive-reared birds wearing satellite transmitters that were released in 2009 in Illinois dispersed as far as Mississippi (~900 km) South Dakota (~1,000 km) and New Jersey (~1,200 km from release site; D. Thompson, pers. comm.) The minimum polygon range of this cohort from October 2009-January 2010 was about 900,000 km² (350,000 square miles; Fig. 7). Whether barn owls are migratory is not fully resolved. Birds that appear to be migrants likely are dispersing juvenile birds. Adult barn owls are sedentary (Marti 1988a, Snow and Perrins 1988), nest at the same site until they die (Colvin et al. 1984, Marti 1999), and often occupy the same territory and roost in the nest site through the winter (Bunn et al. 1982).

After their natal dispersal, adult barn owls typically maintain a smaller home range. Mean home ranges of adult barn owls among four studies was about 420 ha (just over 1,000 acres), ranging from 294 ha (726 acres) in Virginia (Rosenburg 1986), 308 ha (761 acres) in Scotland (Taylor 1994), 369 ha (911 acres) in Texas (Byrd 1982), to 717 ha (1,771 acres) in New Jersey (Hegdal and Blaskiewicz 1984). When hunting for incubating females or nestlings, male barn owls hunt within an area of about 250 ha (about one square mile) on any given night (Michelat and Giraudaux 1991), and the maximum distance from roost sites to hunting areas was 5.6 km (about 3.4 miles; Hegdal and Blaskiewicz 1984).

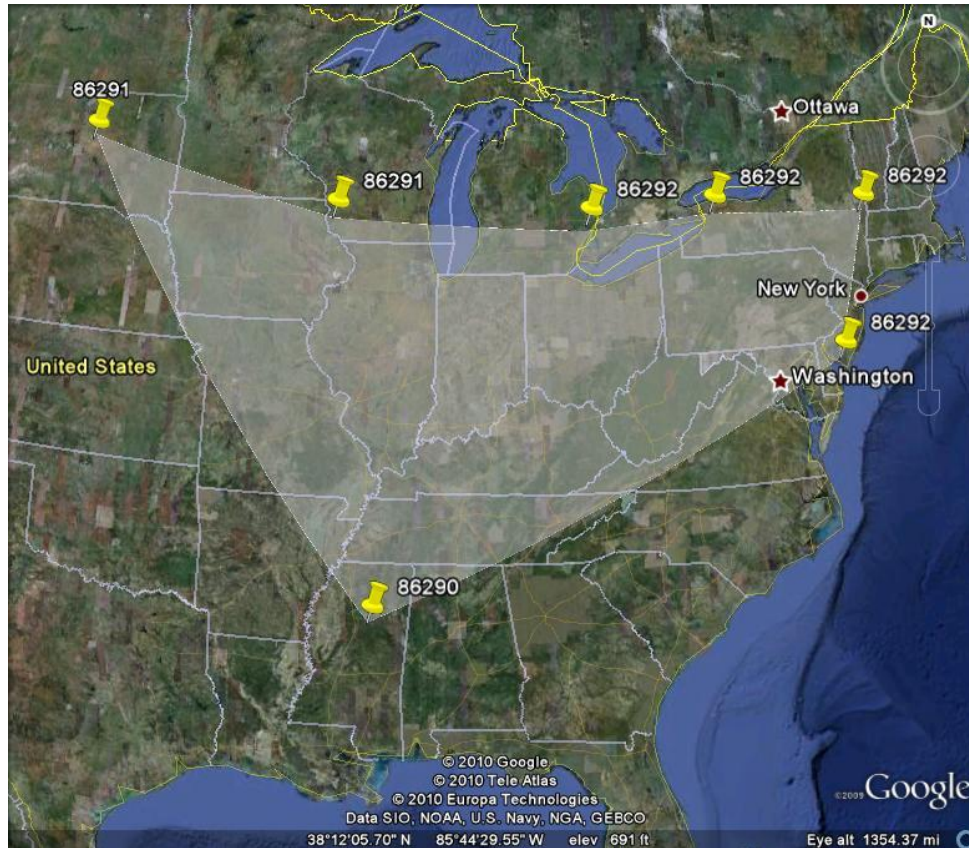

Fig. 7. Limits of the area within which five captive-reared barn owls dispersed from northeastern Illinois, October 2009 to January 2010 (data from D. Thompson, DuPage County Forest Preserve District).

Habitat. Prior to European settlement of the Midwest, barn owls probably nested in oak savannas and hunted in nearby tallgrass prairies (Kirk 1999). Today, barn owls are most often associated with open grassland and agricultural areas, and nest in tree cavities and human structures. Barns, silos, grain bins, and abandoned buildings (including nest boxes placed therein) and tree cavities are typical nesting habitats in Illinois. Barn owls readily adopt nest boxes, and some designs reduce the risk of nest predation.

Typical foraging habitats for barn owls in Illinois are grasslands, marshes, and agricultural fields where they hunt for voles and other small mammals, though they may also forage in and near buildings for mice and rats. Perennial grasslands, including hay fields and pastures, support greater abundances of voles and small mammals than row crop fields (Getz and Brighty 1986, Getz and Hofmann 1999), thus providing superior foraging areas for barn owls.

In Ohio, Shipley et al. (2008) modeled barn owl habitat at landscape (7.5 minute quadrangle) and local (1.6 km radius) scales from active and inactive barn owl nest boxes. At the landscape-scale, active nest boxes were positively associated with foraging habitat (hay/pasture, wet meadow and shallow marsh), woodland, and slope (mean elevation change). At the local-scale, active nests were positively associated with slope and foraging habitat, and negatively associated with woodland. Shipley et al. (2008) suggested slope, *per se*, is not an important factor, but a surrogate for other ecologically important features for barn owls. Areas with greater elevation change are more suitable to hay/pasture agriculture, whereas flatter areas are more likely to be row-cropped. The glaciated-unglaciated border area, from south-central to northeastern Ohio, is a diverse landscape of forest patches and hay/pasture agriculture, and barn owls are common in the grass-dominated openings of this region.

Daytime roosting sites for barn owls must provide security from predators and climatic extremes. Barn owls may roost in their nests at any time of the year (Bunn et al. 1982). Barn owls regularly roost in rafters within barns and other buildings, and in dense woody vegetation near foraging areas. Evergreen trees (*Juniperus* and other conifers) may be especially important.

Metapopulation Dynamics. Although barn owl populations in Illinois and the Midwest are small, they have not been considered fragmented or isolated from more robust populations in other regions (e.g., southern Great Plains and lower Mississippi Valley states). Because juvenile

dispersal distances >100 km are common, local population size is probably only weakly a function of local recruitment and mortality. The rate of emigration of barn owls fledged in Illinois to other states has not been documented, but may be high. The rate at which birds from other states immigrate to Illinois is also unknown.

No studies have looked at issues of genetic relatedness (genetic drift, inbreeding depression) limiting Midwestern barn owl populations. Demographics are a more plausible limiting factor for very low-density barn owl populations. In areas where barn owls are considered common, densities are about one pair per 2 to 5 km² (about 1-2 square miles; Sharrock 1976, Taylor et al. 1988). The density of barn owls in Illinois is far lower, likely 1,000s of km² per breeding pair. Given the short average lifespan of barn owls, the difficulty of locating a suitable mate at very low density may be depressing recruitment into the population.

Interspecific Interactions. Like other cavity nesting birds, barn owls experience strong competition for nest sites. Raccoons (*Procyon lotor*) compete with barn owls for nest sites in tree cavities, within human structures, and in nest boxes, and may be important predators of eggs and nestlings. Barn owls mob mammalian predators that approach their nests. Barn owls likely can displace rock pigeons (*Columba livia*) or European starlings (*Sturnus vulgaris*) that commonly colonize barn owl nest boxes.

Predation of adults is not considered an important factor (Marti et al. 2005). Great horned owls (*Bubo virginianus*) kill about one-half of captive-raised and released barn owls (Ehresman et al. 1988), and probably prey on adult wild barn owls (Milsap and Milsap 1987). Though not documented, red-tailed hawks (*Buteo jamaicensis*) are likely capable of killing adult barn owls. When discovered during the day, barn owls are mobbed by American crows (*Corvus brachyrhynchos*) and other birds.

Competition for voles or other prey is possible, but likely is not a limiting factor for barn owls. Northern harriers (*Circus cyaneus*), short-eared owls (*Asio flammeus*), and long-eared owls (*Asio otus*) use the same grasslands for foraging as barn owls, primarily in winter (D. Thompson, pers. comm., J. Walk, pers. obs.). Thompson (pers. comm.) reported territorial disputes between released barn owls and long-eared owls, though agonistic interactions with northern harriers and short-eared owls have not been reported.

Conservation & Management of Barn Owls

Reasons for Status. Just as definitive data on population trends of barn owls in Illinois and the Midwestern U.S. are lacking, so are data on population regulation and any causes of changes in abundance. Most studies suggest that barn owl populations fluctuate with prey abundance (Marti et al. 2005). In Europe, barn owl populations often fluctuate with cyclic vole populations (Taylor 1994), and prey availability limits reproduction (Taylor 1992).

In the Midwest, several studies have shown that voles (*Microtus spp.*) are important prey for barn owls (Marti et al. 2005). However, voles are much more abundant in hay, pasture, prairie remnants, roadsides, and other perennial grasslands than in cropland (Getz and Brighty 1986, Getz and Hofmann 1999). As a consequence, Colvin (1985) and Peterjohn (1989) implicated large-scale conversion of hay and pasture to row cropping in the Midwest as the most likely cause of barn owl population declines by limiting the availability of suitable prey. Similar land use changes in Europe were also implicated in apparent reductions in barn owl abundance (de Bruijn 1994, Taylor 1994, de Jong 1998).

From 1950 to 2007 in Illinois, the area devoted to hay and pasture decreased by 2.1 million ha (5.1 million acres), whereas corn and soybean acreage increased by 3.7 million ha (9.1 million) acres in spite of an overall reduction in farmland area (U. S. Department of Agriculture 1950, 2007). These land use changes correlate with the declining populations of several other grassland birds as well (Herkert et al. 1996). The establishment of about 324,000 ha (800,000 acres) of grassland conservation practices in the Conservation Reserve Program beginning in the late 1980s presumably created improved foraging habitat for barn owls, and may be contributing to the apparent increase in barn owl reports since 1990. Counties in south-central Illinois, where many of the recent barn owl nest records are located, have large areas enrolled in the Conservation Reserve Program (Fig. 8).

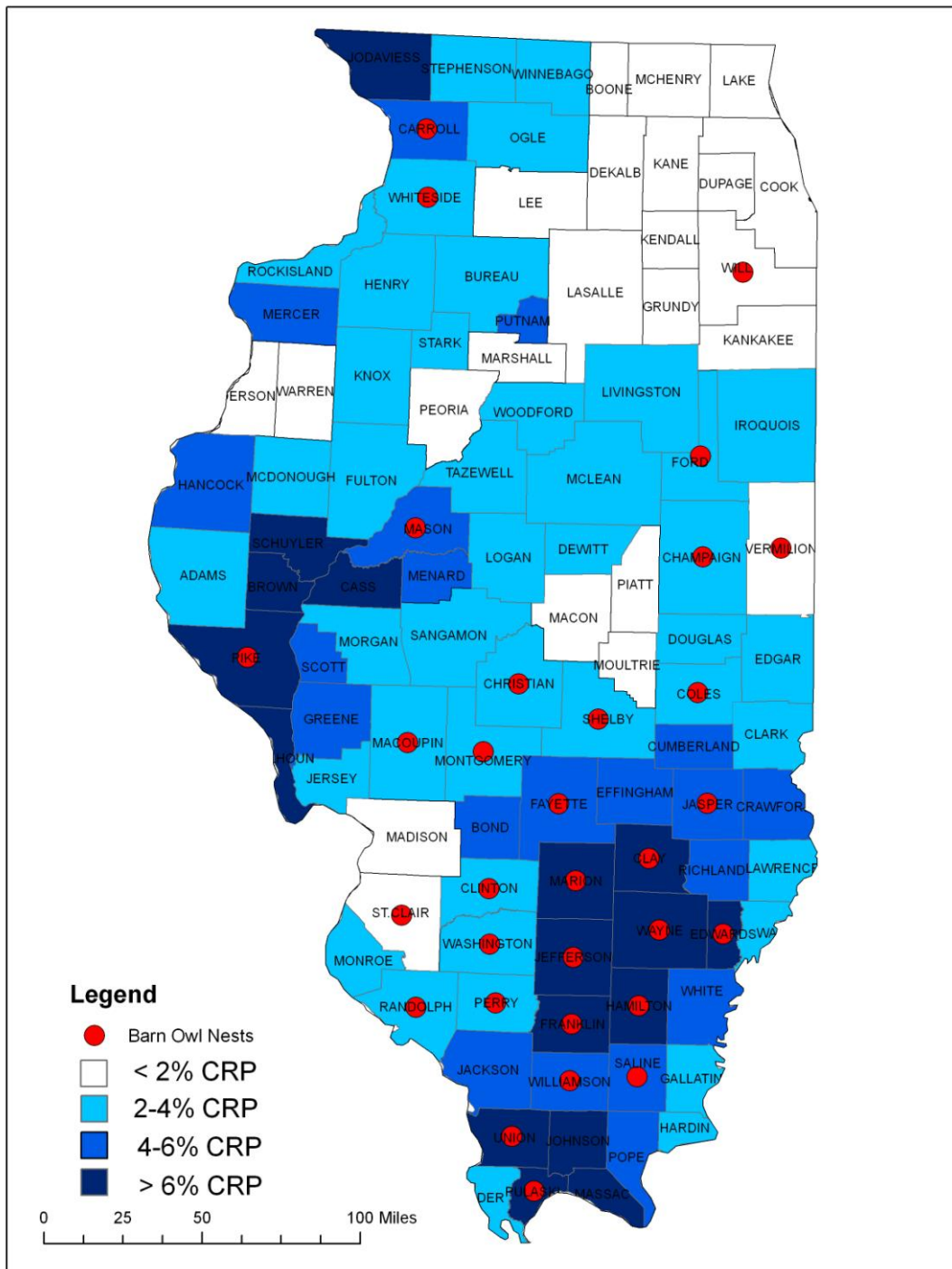

Fig. 8. Counties with barn owl nest records 1990-2009 (circles), relative to the percentage of each county enrolled in the Conservation Reserve Program.

The declining availability of open barns and outbuildings, used by barn owls for nesting, has been concomitant with increasing farm size and land use changes described above, and agricultural intensification in the Midwest (Colvin 1985). Throughout North America and Europe, barn owls have been adversely affected by the loss of old buildings for nesting (Colvin 1984, Taylor 1994, Ramsden 1998). While suitable nest sites may not be the most limiting factor for barn owl populations in Illinois, destruction or disturbance of nest sites (e.g., tree falls; activity in grain bins, silos and barns; demolition of old structures) is the most common way that nesting barn owls are discovered (Illinois Department of Natural Resources, Biotics 4 database).

Pesticides and other contaminants could play a role in low barn owl populations (Colvin 1984). In the United Kingdom, Taylor (1994) implicated aldrin and dieldrin in population declines of the 1950s and 1960s, and Newton et al. (1991) attributed the deaths of 40% of recovered barn owls to pesticides from 1963-1977. Secondary poisoning from the anticoagulants bromadiolone and brodifacoum (used as rodenticides) is a risk since both chemicals have killed captive barn owls (Mendenhall and Park 1980). However, brodifacoum did not affect reproduction or survival of barn owls in New Jersey (Hegdal and Blaskiewicz 1984), and barn owls in England were not exposed to significant rodenticide residues (Eadsforth et al. 1996).

Vehicle collision mortality can be high in barn owls, and at least three Illinois records from 2006-2009 were of road-killed birds. Newton et al. (1997) estimated one-half of all barn owls in the United Kingdom were killed by automobiles and Ramsden (2003) found barn owls were exterminated within 2.5 km of a major road. Collisions with fences, utility lines, guy wires of tall antennae, or other stationary objects have not been reported as important causes of mortality in barn owls.

Other factors, including predation, competition for foraging areas and nest sites, parasites/diseases, and human disturbance and persecution have not been implicated as serious threats that have caused population declines, or that are limiting population recovery (Marti et al. 2005, Ontario Barn Owl Recovery Team 2009). The Ontario Barn Owl Recovery Team (2009) thought barn owls in Ontario had a small chance of locating a mate. This may be the case in other regions where barn owls occur at very low densities, including Illinois.

Conservation Measures. The most frequently undertaken conservation action for barn owls – the deployment of nest boxes – is the only measure that has achieved documented success in increasing barn owls in some areas (Marti et al. 2005). A nest box program in Ohio has increased the number of known nests in the state from <20/year before 1990 to >55/year since 2004 (Ohio Department of Natural Resources 2009). Nest boxes are most likely to benefit barn owls when potential nest sites are not available near foraging areas, and least likely to increase barn owl abundance in regions where prey are scarce. In some areas, barn owls have adopted nest boxes in favor of natural cavities, but not increased in abundance, mostly in regions with low prey abundances (Colvin et al. 1984). There is some evidence that barn owl nests in boxes are more productive than nests in natural nest sites (Bellocq and Kravetz 1993). In Ohio, barn owl nests in nest boxes from 1988-2004 had an 83% success rate, and an average of 4.3 young fledged per nest (Ohio Department of Natural Resources 2009).

Illinois Department of Natural Resources staff and cooperators have erected >100 nest boxes on public and private lands in Illinois since the 1980s. At least 9 of 47 Element Occurrence Records of nesting barn owls have been in boxes or trays places in barns and silos (Illinois Department of Natural Resources, Biotics 4 database). In cases where eggs or nestlings are accidentally discovered, the nest is oftentimes moved into a nest box. Though nest boxes are

damaged or destroyed by normal use of barns and silos, they are typically safe from mammalian predators when installed properly and readily utilized by barn owls, facilitating nest and population monitoring.

Releasing captive-reared barn owls is the other commonly attempted conservation measure, but has not achieved definitive success, likely because captive-raised barn owls are killed and starve more frequently than their wild counter-parts (Fajardo et al. 2000). From 1979 to 1986, about 1,400 captive-reared barn owls were released by rearing programs in Indiana, Iowa, Michigan, Missouri, Nebraska, and Wisconsin (Marti 1988b), resulting in only three known nest attempts (Henke and Crawford 1987). In Wisconsin, Matteson and Peterson (1988) reported “The Bureau of Endangered Resources decided in 1987 to discontinue the captive-propagation and release program since there was no evidence that the program had enhanced the state’s barn owl population.” Dr. Bruce Colvin of the Barn Owl Research Foundation wrote, “The entire episode will probably remain one of the worst examples of wildlife management in the U.S. (making decisions based largely on politics and public relations rather than science).”

A release program in western Pennsylvania of barn owls fitted with satellite transmitters found barn owls dispersed up to 1,200 miles. Because of long-distance dispersal and high mortality, the study concluded that releasing barn owls was not a good strategy, especially in north-central states, and instead recommended that efforts focus on preserving and enhancing habitat and nest box programs (M. Browning, pers. comm., manuscript in prep.).

In Great Britain, releasing barn owls has been even more widely attempted, with the Department of Environment, Food and Rural Affairs estimating 15,000 to 20,000 captive birds were being held in 1991 and a few thousand released each year. The British government banned the release of captive birds in 2001, because “after decades of releasing Barn Owls in the wild,

there was no quantitative evidence that there was any positive impact on natural populations” (Department of Environment, Food and Rural Affairs 2001). Other than an introduction of the North American race of barn owls to the Hawaiian Islands (Berger 1981), attempts of translocating wild barn owls have not been reported.

While changes in land use have almost certainly contributed to increases and decreases in barn owl distribution and abundance over time, habitat management has apparently not been undertaken with the explicit objective of conserving barn owls. Managing grassland foraging habitat for barn owls has been prescribed in conservation plans for barn owls in Ontario (Ontario Barn Owl Recovery Team 2009) and Wisconsin (Matteson and Peterson 1988). Managing habitat specifically for barn owls is complicated by their widespread occurrence at low density, short lifespan, and long-distance natal dispersal. These factors make it difficult to target specific areas to manage habitat for barn owls, or to expect that certain management actions will measurably improve barn owl populations.

Marti et al. (2005) includes U.S. Department of Agriculture conservation programs, such as the Conservation Reserve Program, among the agricultural practices that have “inadvertently” benefited barn owls. Barn owls may have increased in Illinois since the beginning of the Conservation Reserve Program, and several counties with extensive Conservation Reserve Program enrollments have recent barn owl nest records (Fig. 8). In Illinois, grassland habitat at Prairie Ridge State Natural Area, Pyramid State Recreation Area, Cypress Creek National Wildlife Refuge, and possibly other conservation areas have been utilized by barn owls for nesting and foraging.

Recovery Potential. Although barn owls are rare in Illinois, they remain broadly distributed within the state, can quickly colonize areas of suitable habitat, readily adopt nest

boxes, are tolerant of human presence, and are capable of high reproductive output and rapid population growth. Barn owl populations are secure in Mississippi River Valley states south of Illinois, and populations in some Midwestern states (Missouri, Ohio) appear to be expanding. While low availability of grassland foraging habitat is likely a limiting factor, it is plausible that the amount of grassland in Illinois could support more barn owls than are currently known to exist in the State. Though the barn owl is unlikely to become common throughout Illinois, it is feasible to improve the status of the barn owl so that it no longer warrants listing as an Illinois *Endangered* or *Threatened* species. Implementation of the Illinois Wildlife Action Plan's *Farmland & Prairies Campaign* will conserve barn owls and associated grassland and savanna wildlife.

Joint Recovery

Ecosystem Restoration & Management. Historically, barn owls probably occurred in transition areas from oak savannas to tallgrass prairies, nesting in tree cavities and hunting voles and other small mammals in nearby grasslands (Kirk 1999). Within Illinois, prairies and savannas have been largely converted to other land uses, such as agriculture and development, and few large, high-quality remnants of these communities remain in Illinois (White 1978, McClain 1986, Nuzzo 1986). The 1999-2000 Land Cover of Illinois reported about 600,000 acres of partial-canopy/open woodland (much of this has a savanna-like structure) and more than 4 million acres of rural grassland (Illinois Department of Agriculture 2001). Though the herbaceous layer of these habitats is mostly dominated by introduced grasses, native wildlife (including barn owls) have adopted these surrogate habitats to varying degrees.

Barn owls are wide-ranging predators characteristic of the grassland-open woodland ecotone, and habitats used by barn owls support a diverse array of other *Species in Greatest Need of Conservation*. As indicated previously, targeting areas to improve habitat for barn owls is complicated by their occurrence at low density and high dispersal. Efforts to protect and restore prairies and savannas, and sites targeting conservation of other species (e.g., upland game birds at Habitat Areas) are likely to benefit barn owls. Three tasks described in the *Farmland & Prairies Campaign* will be directly related to the recovery of the barn owl and associated species:

- a. *Through incentives-based programs and technical assistance, establish or restore grassland, early successional/shrub, wetland, and riparian habitat.*
- b. *Through incentives-based programs and technical assistance, moderate disturbance regimes and enhance the condition of farmland habitats.*
- c. *Restore and manage native prairie communities and populations of imperiled and extirpated prairie wildlife.* (Illinois Department of Natural Resources 2005:73-74)

Species in Greatest Need of Conservation. The areas used by foraging barn owls are not precisely known, and determining the other species utilizing these same areas is difficult. Of the hundreds of insect *Species in Greatest Need of Conservation*, most are associated with prairie or savanna habitats and few have been surveyed statewide to determine their full distribution. Conservation of prairies and savannas throughout Illinois could plausibly be mutually beneficial to barn owls and any of these insects. Bouseman (1997) and LaGessee and Wiker (2008) sampled insects at sites occupied by barn owls in south-central Illinois and reported 46 insects listed as *Species in Greatest Need of Conservation* or rarely occurring in Illinois (Appendix I). Among

the insects found in barn owl nesting areas is *Papaipema eryngii*, the rattlesnake master borer moth, which is being reviewed by the U.S. Fish & Wildlife Service for listing under the Endangered Species Act. At least 2 amphibians, 9 reptiles, 30 birds and 3 mammals considered *Species in Greatest Need of Conservation* share habitat affinities with barn owls (Appendix I), and should be considered for joint recovery actions.

Recovery

Definitions. The Illinois Endangered Species Protection Board has determined the barn owl is *Endangered in Illinois*. For the purposes of this plan, the definitions of “endangered” and “threatened” as excerpted from the Illinois Endangered Species Protection Act (520 ILCS 10/2) are:

Endangered in Illinois – in danger of extinction in the wild in Illinois due to one or more causes including but not limited to, the destruction, diminution or disturbance of habitat, overexploitation, predation, pollution, disease, or other natural or manmade factors affecting its prospects of survival.

Threatened in Illinois – likely to become endangered in the wild in Illinois within the foreseeable future.

We narrowly define the recovery of the barn owl as a determination of the Illinois Endangered Species Protection Board that the definition of ‘threatened’ no longer applies to the barn owl in Illinois (i.e., the barn owl population is sufficiently secure so as to not likely become endangered in the wild in Illinois within the foreseeable future).

Objectives & Criteria. The Illinois Endangered Species Protection Board is required by law to review, and revise as necessary, the list of *Illinois-Endangered* and *-Threatened* species at least every five years. The distribution and abundance of barn owls is reviewed by the Board as part of these periodic updates (as in 1999, 2004, and 2009) to determine whether a change in status should be considered. We propose that measures of population size and distribution, as documented in the Illinois Department of Natural Resources' Biotics 4 database, be used to trigger a detailed review of the barn owl's status by the Illinois Endangered Species Protection Board. Achieving the levels of population size and distribution proposed in this plan shall not prompt an 'automatic' change in the status of the barn owl in Illinois. Other factors, including known threats, nest productivity, and extent and condition of protected habitat, should be considered with population size and distribution data to judge whether a change in status is warranted.

Change from Endangered to Threatened in Illinois – The Illinois Endangered Species Protection Board shall thoroughly evaluate the status of the barn owl and consider a change in status from *Endangered* to *Threatened* when, over the past 5 years, the Biotics 4 database has Element Occurrence Records of 40 active nest sites distributed among at least 15 counties. A nest site active in >1 year of the 5-year interval is considered a single record. The Illinois Endangered Species Protection Board should judge the threats to the population, to nesting sites, and to barn owl habitat are low to moderate, or manageable with existing conservation resources. The reverse of these conditions could be used to consider a change from *Threatened* to *Endangered* should the population's condition degrade at some future point following an improvement in status.

Removal from Threatened in Illinois (Recovered) - The Illinois Endangered Species Protection Board shall thoroughly evaluate the status of the barn owl and consider a change in status from *Threatened* to recovered when, over the past 5 years, the Biotics 4 database has Element Occurrence Records of 80 active nest sites distributed among at least 30 counties. A nest site active in >1 year of the 5 year interval is considered a single record. The Illinois Endangered Species Protection Board should judge that the threats to the population, nesting sites, and barn owl habitat are low. The population should be likely to persist at similar levels with sustainable conservation actions (e.g., nest box maintenance and monitoring program, with responsibility for program continuation assigned to one or more entities). The reverse of these conditions could be used to consider a change to *Threatened* should the population's condition degrade at some future point following recovery.

These population size and distribution objectives represent greater barn owl abundance and distribution than observed in Illinois over the past 40 years, and are intermediate to benchmarks recently applied in Midwestern states. From various sources (including reports of the Illinois Ornithological Records Committee, *Illinois Birds & Birding*, *American Birds*, Mlodinow 1984, Bohlen 1989, and Robinson 1996), we have found reports of six barn owl nests (29 total reports) during the 1970s (the barn owl was listed as *Endangered in Illinois* in 1978). Through the 1980s, only three nesting Element Occurrence Records were reported. In the 2000s, 29 nesting Element Occurrence Records were reported to the Biotics 4 database from 21 of 102 Illinois counties. By comparison, Missouri de-listed the barn owl in 2008 when the Missouri Natural Heritage database had 90 total records from 34 of 114 counties, from the 1980s through 2008 (Missouri Department of Conservation 2008). In Ohio, where the barn owl is listed as threatened, an average of 40 nest boxes have been occupied each year from 1990-2009, with 77

occupied nest boxes in 2009 (Ohio Department of Natural Resources 2009). In most years, barn owls nest in fewer than 15 of Ohio's 88 counties.

An analysis of barn owl nesting records in the Biotics 4 database suggests barn owls may be sufficiently well-distributed, but not reported frequently enough, to prompt a status review. In the past five years (2005-2009), 19 barn owl nest locations were reported from 18 counties (Table 1). Additional survey and reporting effort may determine barn owls are sufficiently abundant to warrant a review of status.

Table 1. Number of nest records and number of counties with nest records of barn owls over the preceding three 5-year intervals, as reported to the Illinois Department of Natural Resources' Biotics 4 database. At least 40 nest records from 15 counties in a 5-year interval are necessary to prompt a review of the barn owl's status in Illinois.

5-Year Interval	# Nest Records	# Counties With Nest Records
2005-2009	19	18
2000-2004	11	11
1996-2000	5	5

Prioritized Strategies.

Deploy and monitor nest boxes within plausible nesting areas. Barn owls readily adopt nest boxes of various designs. There is some evidence that barn owl nests in boxes are more productive than nests in natural cavities. Nest boxes have been documented to increase barn owl abundance in regions with adequate prey. Even in areas where foraging habitat is scarce and prey abundance may be limiting, nest boxes can provide useful conservation information. Because nest boxes can be easily monitored – and barn owl nests in other situations are difficult to locate – the deployment and monitoring of nest boxes is the only known, practical proxy for assessing the status and trend of local barn owl populations. Nest boxes are generally a low-cost, ‘no regrets’ strategy for conserving barn owls. Nonetheless, several factors should be considered when deploying nest boxes, including regional climate suitability, nearby foraging habitat, proximity to known nesting barn owls, proximity to major roads, ease of monitoring/maintenance, and potential for disruption during nesting (Appendix II includes ratings for these factors).

One of the preferred designs for a barn owl nest box to be installed within another structure was developed by Colvin (1983) and has been used successfully in Illinois (Fig. 9; Frontispiece). Several similar designs have also been used with success. An opening directly to an exterior surface of the structure is ideal because it affords protection from some predators or nest competitors (e.g., raccoons). In some cases, an additional opening to the exterior may not be practical or acceptable, but the structure is still a good candidate for a nest box.

In areas where an existing structure is not available for installing a nest box, a free-standing design may be considered. To our knowledge, such free-standing nest boxes have not

been deployed or evaluated in Illinois. In 2010, free-standing nest boxes will be installed as an experimental component of the barn owl recovery project.

A barn owl nest box program is currently the only viable method to monitor barn owl populations. When placed in suitable areas, ‘sentinel’ nest boxes are readily adopted by barn owls. As occupied boxes are documented with annual monitoring, additional boxes can be installed in the area to determine the size and extent of a local barn owl population. Ohio has successfully used such a program since 1988. Annual monitoring of the nest boxes can reveal changes in occupancy rates, which probably reflect true changes in local barn owl abundance. Two to three nest box checks within a season can provide additional information on nest productivity, such as clutch size, hatching rates, and number of fledglings per nest.

Barn Owl Nest Box

- A. Interior of barn wall
- B. Wire (or wood) support if beam is narrow
- C. Latch
- D. Entrance
- E. Cross Beam
- F. Entrance (6" x 6")

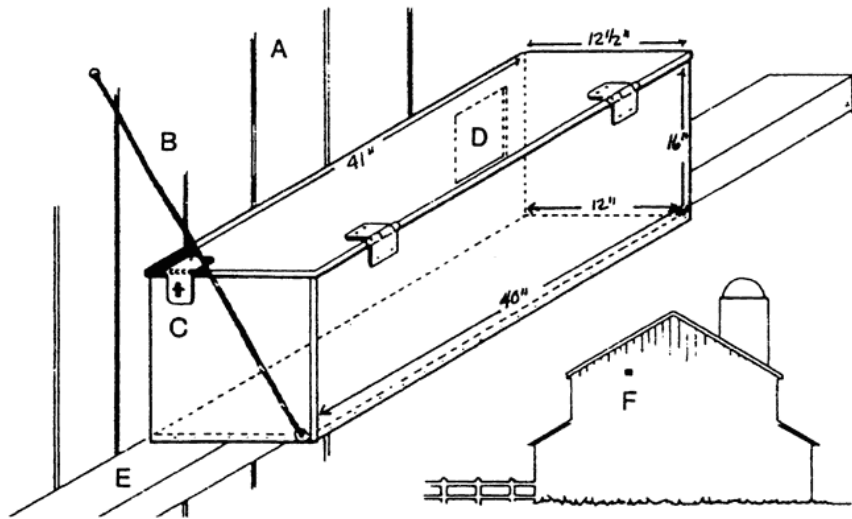

Fig. 9. A recommended design for a barn owl box, installed within a structure, with an opening directly to the structure’s exterior (after Colvin 1983). The barn owl on the Frontispiece utilized a box of this design.

Do not interfere with young barn owls during fledging. As with any other species of bird, people should be strongly discouraged from picking up fledgling barn owls and attempting to “help.” Young barn owls within a clutch may vary in age by up to 14 days, so it is normal for younger birds to remain in the nest after the oldest siblings fledge. The smaller birds are likely not diseased or malnourished, and their best chance for survival is to be left in the care of their parents.

Because many barn owl nests are discovered when the nest is damaged or disturbed, injured young barn owls are frequently captured and taken to wildlife rehabilitators. From 2004-2009, at least 6 of 21 Element Occurrence Reports include details of one or more young brought to wildlife rehabilitators, but in only 2 of these cases were the young birds described as injured. Bringing birds into captivity should be done as a last resort, as rehabilitated birds have lower survival than wild birds (Fajardo et al. 2000). Unless a young barn owl is seriously injured, biologists should either not interfere, or move the bird(s) to a very close safe location, such as a nest box. When their nest has been destroyed or disturbed, adult barn owls will typically resume care of their young that have been moved into a nest box.

Expand dedicated grassland conservation areas. Barn owls have colonized some grassland conservation areas in Illinois, including both units of Prairie Ridge State Natural Area (Jasper and Marion counties) and Pyramid State Recreation Area (Perry County). Barn owls have utilized early successional tree plantings at the Grassy Slough Preserve and Cypress Creek National Wildlife Refuge (Johnson and Pulaski counties). Expanding grassland sites and creating additional sites dedicated to conserving grassland wildlife are likely to benefit barn owls and other *Species in Greatest Need of Conservation*. Grassland wildlife are among the most

imperiled in the state, making the need for dedicated grassland conservation areas particularly acute. Under the action to “Restore and manage native prairie communities and populations of imperiled and extirpated prairie wildlife” in the Illinois Wildlife Action Plan’s *Farmland & Prairies Campaign* are several specific strategies reflecting the need for dedicated grassland conservation areas:

- a. *establish five additional “ecological pattern” grassland Bird Conservation Areas (see Fitzgerald et al. 2000), each of >3,000 acres, in the Southern Till Plain (2) and Grand Prairie (3) natural divisions (Midewin National Tallgrass Prairie, Prairie Ridge State Natural Area [Jasper and Marion county units], and Pyramid State Park are considered as existing grassland Bird Conservation Areas, but need restoration or augmentation)*
- b. *restore and manage 3 wet prairie areas of 1,000 to 2,000 acres, connected by dispersal corridors, in east-central and northwestern portion of Grand Prairie natural division*
- c. *restore and manage at least 6 areas (of 300-500 acres each) of ephemeral wetlands and accompanying upland sand prairie habitat in the inland sand areas*
- d. *restore and manage high-quality examples of all prairie communities, including all Grade A and B Illinois Natural Areas Inventory sites, in all natural divisions within which they occur (Illinois Department of Natural Resources 2005: 75)*

Encourage land use practices that support populations of voles (Microtus spp.) and other small mammals. Perennial grassy habitats, like hay fields, pastures, wet meadows, and Conservation Reserve Program grasslands all support greater populations of small mammals, especially voles, than do row crops. Several grassland focus areas eligible for the State Acres for

Wildlife Enhancement (SAFE) - CP-38, an extension of the Conservation Reserve Program, are a current opportunity to establish grassland foraging habitat for barn owls in landscapes most suitable to other grassland wildlife. There are recent barn owl nest records in or near all the SAFE-eligible areas in the Southern Till Plain natural division, for example (T. Esker, M. Alessi, pers. obs.).

A low concentration of suitable foraging habitat is probably the ultimate factor causing the low abundance of barn owls in the Midwest. Small grasslands in heavily forested areas (>50% wooded) are less likely to be utilized by barn owls. In contrast to some other area-sensitive grassland birds like upland sandpipers (*Bartramia longicauda*) and greater prairie-chickens (*Tympanuchus cupido*), there is no evidence that large grasslands with few trees are required by barn owls. Under the action “Through incentives-based programs and technical assistance, moderate disturbance regimes and enhance the condition of farmland habitats” in the Illinois Wildlife Action Plan’s *Farmland & Prairies Campaign* are several practices suggested to improve the quality of grassland habitats:

- a. *re-seeding/restoring habitats dominated by undesirable species (e.g., conversion of tall fescue to native warm-season grasses)*
- b. *use soil disturbance, prescribed fire and managed grazing to enhance grassland structure and floral diversity, and to control woody vegetation*
- c. *discourage mowing of idle grasslands during wildlife nesting seasons, and eliminate unnecessary mowing*
- d. *use mechanical removal and prescribed fire to maintain shrub/successional habitat and broad transitions between open and wooded habitat types (Illinois Department of Natural Resources 2005: 74)*

Build Public Awareness of Barn Owls & Support for Barn Owl Conservation.

Educational materials and outreach efforts are important to several aspects of barn owl recovery. Barn owls probably occur more often in Illinois than records indicate, so encouraging the public (especially private land owners) to report barn owls will help monitor the barn owl's true distribution in Illinois. The cooperation of private landowners will be essential for deploying and monitoring nest boxes, and enhancing grassland habitat. Volunteer groups, such as 4-H clubs, scout troops, Future Farmers of America chapters, and Audubon societies, may be willing to monitor local nest boxes and report their findings.

Research of Barn Owl Ecology & Behavior. Barn owls sometimes respond to broadcasts of barn owl sounds, and similar 'playbacks' are key components of monitoring programs for other secretive birds, including marsh birds (Conway and Nadeau 2006) and other species of owls in the Monitoring of Owls and Nightjars (MOON) program in Illinois. However, it is unknown whether vocal responses to broad cast calls are typical or atypical barn owl behavior.

Conspecific attraction (by recorded sounds and/or models [decoys]) has also been used successfully to draw birds into suitable but unoccupied habitats for nesting. However, the roles of various barn owl vocalizations have not been studied in the North American race. Different vocalizations may elicit attraction, avoidance, or aggression responses, and response may vary by gender. Whether barn owls can be encouraged to settle in an area with playback recordings should be investigated.

Recent studies of released captive-reared barn owls fitted with satellite transmitters have greatly expanded our knowledge of the dispersal ecology of young barn owls. These owls

typically travel several hundred kilometers, experience high first-winter mortality, rarely return to locations near their release sites, and rarely nest and raise their own young. For these reasons, releasing barn owls by any method developed to date is not a viable recovery strategy.

Because barn owls readily breed in captivity, young birds are readily available for release. It is possible to avoid this scenario by keeping adult barn owls separate, neutering captive adults, or destroying or oiling eggs. In any future experimental release of captive-reared barn owls, researchers should investigate whether the behaviors of released birds are comparable to wild birds, and evaluate the potential for disease transmission from released birds to wild birds. For example, the reticuloendotheliosis virus (REV) infects waterfowl, gallinaceous birds, and probably other birds. The REV has been identified as a potential problem for releases of captive-reared Attwater's prairie-chickens (*T. cupido attwateri*; Drew et al. 1998).

Monitoring & Evaluation

Progress towards the recovery of barn owls can be measured by outputs (the activities performed by conservationists) and outcomes (the population response). While outcomes are the ultimate determinant of a successful recovery, many uncontrollable factors beyond conservation actions may affect population response. Effectiveness measures (outcomes/outputs, or population response per unit of conservation effort) are useful for evaluating the degree to which conservation actions address factors limiting populations, and evaluating the costs/benefits of alternative actions. This section focuses on recovery activities initiated in the first five years of this plan.

Implementation of strategies will be dependent upon availability of funding and resources. Upon determination to engage implementation, the Illinois Department of Natural Resources will utilize an annual work plan process to develop an Annual Barn Owl Recovery Work Plan to outline and schedule recovery plan strategy activities and identify necessary resources and personnel. Illinois Department of Natural Resources staff from the recovery plan team (Maggie Cole, Terry Esker) will participate in the annual work plan process.

Recovery Strategy 1: Deploy and monitor nest boxes within plausible nesting areas. The near-term objective of this strategy is to increase the number of known barn owl nests in Illinois. Longer-term, monitoring nest boxes will serve as a proxy for monitoring barn owl population changes.

Outputs:

- a. Install at least 25 new nest boxes per year in plausible nesting areas (Years 1-5). Focus the deployment of additional nest boxes in the vicinity of occupied nest boxes or incidentally-discovered barn owl nests to help define the extent of local populations. Nest box locations scoring ≥ 7 on factors described in Appendix II are most likely to benefit barn owls.
- b. Revisit an additional 25 nest boxes (deployed prior to 2009) to find evidence of use (pellets, feathers), determine nest box condition, and replace if damaged/destroyed as appropriate, based on local conditions (Years 1-5).
- c. Monitor nest boxes considered in (a) and (b) above annually (50 boxes in Year 2 and an additional 50 boxes/year until 250 boxes are monitored annually in Year 6 and after).

- d. Report evidence of barn owl nesting in nest boxes and other situations to the Illinois Department of Natural Resources Biotics 4 database (Annual).

Outcomes:

Number of occupied barn owl nest boxes (Annual).

Number of counties with nesting barn owls (Annual).

Number of Element Occurrence Reports of nesting barn owls (Annual).

Recovery Strategy 2: Do not interfere with young barn owls during fledging.

Output:

- a. Communicate to field biologists in the Illinois Department of Natural Resources, county forest preserve districts, other agencies or organizations, and to wildlife rehabilitators on the appropriate handling of situations when nestling or fledgling barn owls are discovered (Year 1). Recommend that not interfering with nesting or fledging is the best option, that barn owls only be captured when they are in immediate danger and moved to the nearest safe location, and that only injured barn owls are taken to wildlife rehabilitators. Biologists should give the same advice to persons discovering nestling or fledgling barn owls. Any barn owl brought to a wildlife rehabilitator should be reported to the Illinois Department of Natural Resources. Any injured barn owl that is rehabilitated should be released near the site where it was initially found.

Outcome:

Number of uninjured juvenile owls brought to wildlife rehabilitators and reported to the Illinois Department of Natural Resources (Annual).

Recovery Strategy 3: Expand dedicated grassland conservation areas.

Outputs:

- a. Protect additional areas (and restore to grassland habitat if necessary) at dedicated grassland conservation areas, as opportunities become available, averaging 200 acres protected per year (Years 1-5). Protection may include acquisition, permanent easement, or dedication as a Nature Preserve or Land & Water Reserve.
- b. Install additional barn owl nest boxes at grassland conservation areas (Annual).
- c. Monitor barn owl nest boxes at grassland conservation areas (Annual).
- d. Report evidence of barn owl nesting in nest boxes at grassland conservation areas to the Illinois Department of Natural Resources Biotics 4 database (Annual).

Outcome:

Number of Element Occurrence Reports of nesting barn owls at grassland conservation areas (Annual).

Recovery Strategy 4: Encourage land use practices that support populations of voles (*Microtus spp.*) and other small mammals.

Outputs:

- a. Establish or enhance (through prescribed fire, re-seeding, invasive species control, improved grazing practices, or mechanical disturbance) 2,000 acres of grassland on private lands each year (Years 1-5). Acreages established to grasslands through Farm Bill programs (e.g., Conservation Reserve Program) may greatly exceed this objective, but should be focused in areas most likely to benefit barn owls (i.e., locations scoring ≥ 7 on factors described in Appendix II).
- b. Enhance (through prescribed fire, re-seeding, invasive species control, improved grazing practices, or mechanical disturbance) 1,000 acres of grassland on public lands each year (Years 1-5). Habitat enhancement in locations scoring ≥ 7 on factors described in Appendix II are most likely to benefit barn owls.

Outcomes:

Number of occupied barn owl nest boxes (Annual).

Number of counties with nesting barn owls (Annual).

Number of Element Occurrence Reports of nesting barn owls (Annual).

Recovery Strategy 5: Build Public Awareness of Barn Owls & Support for Barn Owl Conservation.

Outputs:

- a. Develop an informational brochure on barn owls and barn owl conservation in Illinois for distribution to the public (Year 1). A print version could be available for venues such as the Illinois State Fair and the U. S. Department of Agriculture's county Service Centers. Post an electronic version on the Illinois Department of Natural Resources' and Illinois Endangered Species Protection Board's websites.
- b. Publish biennial reports on barn owl recovery progress on the Illinois Department of Natural Resources' and Illinois Endangered Species Protection Board's websites (Years 1, 3, 5).
- c. Publish an article on barn owls and barn owl conservation in Illinois through a popular outlet, such as *OutdoorIllinois* (Year 2).

Outcomes:

Number of reports of barn owls from citizens to the Illinois Department of Natural Resources (Annual).

Number of nest boxes installed on private lands at the landowner's request (Annual).

Number of nest boxes monitored by volunteer cooperators (Annual).

Number of Element Occurrence Reports of nesting barn owls on private lands (Annual).

Recovery Strategy 6: Research of Barn Owl Ecology & Behavior.

Outputs:

- a. Evaluate the effectiveness of playback recordings to attract barn owls to unoccupied nest boxes (Year 1-3). Attempt at >1 site per year.
- b. Solicit volunteers from at least 10 MOON routes in the southern ½ of Illinois (where barn owls are most likely to be encountered) to add barn owl vocalizations to the protocol (Years 1-5). If detections exceed >1 barn owl/10 routes/year, expand the protocol to include barn owls on other routes.

Outcomes:

Number of occupied barn owl nest boxes (Annual).

Number of Element Occurrence Reports of nesting barn owls (Annual).

Number of barn owls detected on MOON routes in Illinois (Annual).

Table 2. Suggested annual schedule for barn owl recovery actions.

January	Recovery activities of IDNR staff are included in plan of work process
February	
March	Review barn owl recovery plan
April	Peak of barn owl nest initiations
May	Check nest boxes for evidence of use (May-July)
June	
July	Report any barn owl nesting records to Biotics 4 database
August	Deploy, repair nest boxes (August-February)
September	Compile records of any barn owls brought to wildlife rehabilitators, and report to Biotics 4 database
October	Compile information on annual grassland habitat protection, and habitat improvements on public and private lands
November	
December	Complete and post biennial progress reports on barn owl recovery

Recovery Plan Review & Revision

This plan will be reviewed annually in the context of the Annual Barn Owl Recovery Work Plan development process, but the need for revisions to the plan may be identified at any time. All substantive revisions to this plan, including but not limited to recovery objectives and recovery strategies, should be considered a new recovery plan and follow the protocol described

in “The Illinois Department of Natural Resources’ Recovery Planning in the Office of Resource Conservation” (current version). As such, recovery planning may be initiated by any staff and follows an established process to ensure proper review and potential conflicts are identified.

Updated information – such as new data on barn owl distribution and abundance, research results relevant to recovery considerations, changes in barn owl taxonomy or nomenclature, and corrections to factual errors in this document – may be posted as addendums to the recovery plan without changing the original document.

This recovery plan is approved upon the date of signature and shall be considered the primary reference document for review and implementation by the Illinois Department of Natural Resources and Illinois Endangered Species Protection Board of recovery activities for the barn owl (*Tyto alba*) in Illinois.

Signature on file, dated 1 November 2010

James R. Herkert

Date

Director of the Office of Resource Conservation

Illinois Department of Natural Resources

Signature on file, dated 12 November 2010

R. Daniel Gooch

Date

Chair, Illinois Endangered Species Protection Board

Literature Cited & Data Sources

- Belloq, M. I. and F. O. Kravetz. 1993. Productivity of *Tyto alba* (Barn Owl) in Pampean agrosystems. *Hornero* 13:277-282.
- Berger, A. J. 1981. Hawaiian bird life. University of Hawaii Press, Honolulu.
- Bohlen, H. D. 1989. Birds of Illinois. Indiana University Press, Bloomington.
- Bouseman, J. K. 1997. Survey of select insects on protected prairies in the Southern Till Plain. Report to the Illinois Department of Natural Resources, Springfield.
- Bruce, M. D. 1999. Family Tytonidae (Barn-owls). Pages 34-75 in Handbook of the birds of the world. Vol. 5. Barn-owls to hummingbirds. (del Hoyo, J., A. Elliott, and J. Sargatal, editors) Lynx Edicions, Barcelona, Spain.
- Bühler, P. and W. Epple. 1980. Die Lautäusserungen der Schleiereule (*Tyto alba*). *Journal of Ornithology*. 121:36-70.
- Bunn, D. S., A. B. Warburton, and R. D. S. Wilson. 1982. The barn owl. Buteo Books, Vermillion, South Dakota.
- Byrd, C. L. 1982. Home range, habitat and prey utilization of the Barn Owl in south Texas. M. S. Thesis. Texas A & I University, Kingsville.
- Colvin, B. A. 1983. Nest boxes for barn owls. Publication 346(183). Ohio Department of Natural Resources, Columbus.
- Colvin, B. A. 1984. Barn owl foraging behavior and secondary poisoning hazard from rodenticide use on farms. Ph.D. Dissertation. Bowling Green State University, Ohio.
- Colvin, B. A. 1985. Common Barn Owl population decline in Ohio and the relationship to agricultural trends. *Journal of Field Ornithology*. 56:224-235.

- Colvin, B. A., P. L. Hegdal, and W. B. Jackson. 1984. A comprehensive approach to research and management of Common Barn Owl populations. Pages 270-282 *in* Proceedings of the Workshop on Management of Nongame Species and Ecological Communities. University of Kentucky, Lexington.
- Conway, C. J., and C. P. Nadeau. 2006. Development and field testing of survey methods for a continental marsh bird monitoring program in North America. Wildlife Research Report # 2005-11. USGS Arizona Cooperative Fish and Wildlife Research Unit, Tucson.
- de Bruijn, O. 1994. Population ecology and conservation of the Barn Owl *Tyto alba* in farmland habitats in Liemers and Achterhoek (The Netherlands). *Ardea* 82:1-109.
- de Jong, J. 1998. Slow recovery of the Barn Owl. *Levende Nat.* 99:99-107.
- Department of Food, Environment and Rural Affairs. 2001. The Captive Barn Owl Release Scheme- Consultation Paper. www.defra.gov.uk/wildlifecountryside/consult/barnowl/consultdoc.pdf
- Dickinson, E. C. (editor). 2003. The Howard and Moore complete checklist of the birds of the world. Revised and enlarged 3rd edition. Princeton University Press, Princeton, New Jersey.
- Drew, M. L., W. L. Wagle, D. L. Graham, C. P. Griffin, N. J. Silvy, A. M. Fadly, and R. L. Witter. Reticuloendotheliosis in captive greater and Attwater's prairie chickens. *Journal of Wildlife Diseases* 34: 783-791.
- DuPage County Forest Preserve District. Barn owl recovery project. D. Thompson, ecologist. <http://www.dupageforest.com/page.aspx?id=4294967687>
- Eadsforth, C. V., A. Gray, and E. G. Harrison. 1996. Monitoring the exposure of Barn Owls to second-generation rodenticides in southern Eire. *Pesticide Science* 47:225-233.

- Ehresman, B. L., D. A. Reeves, and K. P. Schlarbaum. 1988. Post release survival and movements of captively reared Common Barn-Owls in Iowa. Annual Symposium of Native Wildlife Rehabilitators Association 7:133-150.
- Fajardo, I., G. Babiloni, and Y. Miranda. 2000. Rehabilitated and wild Barn Owls (*Tyto alba*): dispersal, life expectancy and mortality in Spain. Biological Conservation 94:287-295.
- Fitzgerald, J. A., J. R. Herkert, and J. D. Brawn. 2000. Bird conservation plan for the prairie peninsula (physiographic area 31) Version 1.0. Partners in Flight, American Bird Conservancy.
- Getz, L.L., and E. Brighty. 1986. Potential effects of small mammals in high-intensity agricultural systems in east-central Illinois, U.S.A. Agriculture, Ecosystems and Environment 15: 39-50.
- Getz, L. L., and J. E. Hofmann. 1999. Diversity and Stability of Small Mammals in Tallgrass Prairie Habitat in Central Illinois, USA. Oikos 85:356-363.
- Hands, H. M., R. D. Drobney, and M. R. Ryan. 1989. Status of the Common Barn-Owl in the northcentral United States. Missouri Cooperative Fish and Wildlife Research Unit, Columbia.
- Hegdal, P. L. and R. W. Blaskiewicz. 1984. Evaluation of the potential hazard to Barn Owls of talon (brodifacoum bait) used to control rats and house mice. Environmental Toxicology and Chemistry 3:67-179.
- Henke, R. J. and W. C. Crawford. 1987. Common Barn Owls from captive propagation found nesting in the wild. Journal of Raptor Research 21:74.

- Herkert, J. R., D. W. Sample, and R. E. Warner. 1996. Management of Midwestern grassland landscapes for the conservation of migratory birds. Pages 89–116 in F. R. Thompson III (editor). Management of Midwestern landscapes for the conservation of neotropical migratory birds. USDA Forest Service North Central Forest Experiment Station General Technical Report NC-187, St. Paul, Minnesota.
- Illinois Department of Agriculture. 2001. Land cover of Illinois 1999-2000.
<http://www.agr.state.il.us/gis/landcover99-00.html>
- Illinois Department of Natural Resources. 2005. Illinois Wildlife Action Plan.
<http://dnr.state.il.us/orc/wildliferesources/theplan/>
- Illinois Department of Natural Resources. 2009. Biotics 4 database. T. Kienenger, manager.
[Nesting records 1984-2009 were made available through a data use agreement.]
- Illinois Natural History Survey. 2009. Spring Bird Count database.
<http://www.inhs.uiuc.edu/databases/sbc/about.html>
- Illinois State Climatologist Office. 2009. Climate Maps for Illinois. Illinois State Water Survey.
<http://www.isws.illinois.edu/atmos/statecli/Mapsv2/index.htm>
- Keran, D. 1981. The incidence of man-caused and natural mortalities to raptors. Raptor Research 15:108-112.
- Kirk, D.A. 1999. COSEWIC update status report on the Barn Owl, *Tyto alba*. Committee on the Status of Endangered Wildlife in Canada, Ottawa, Ontario.
- Kleen, V. M., L. Cordle, and R. A. Montgomery. 2004. The Illinois Breeding Bird Atlas. Special Publication No. 26. Illinois Natural History Survey, Champaign.
- LaGesse, V. L., and J. R. Wiker. 2008. An insect survey of the upper Little Wabash watershed. Report to Ballard Nature Center, Altamont, Illinois.

- Marti, C. D. 1988a. A long-term study of food-niche dynamics in the Common Barn Owl: comparisons within and between populations. *Canadian Journal of Zoology* 66:1803-1812.
- Marti, C. D. 1988b. The Common Barn Owl. Pages 535-550 *in* Audubon Wildlife Report 1988/1989. (W. J. Chandler, editor.) Academic Press, San Diego.
- Marti, C. D. 1990. Sex and age dimorphism in the Barn Owl and a test of mate choice. *Auk* 107:246-254.
- Marti, C. D. 1997. Lifetime reproductive success in Barn Owls near the limit of the species' range. *Auk* 114:581-592.
- Marti, C. D. 1999. Natal and breeding dispersal in Barn Owls. *Journal of Raptor Research* 33:181-189.
- Marti, C.D., A.F. Poole, and L.R. Bevier. 2005. Barn Owl (*Tyto alba*). *The Birds of North America Online* (A. Poole, editor). Cornell Laboratory of Ornithology, Ithaca, New York. http://bna.birds.cornell.edu/BNA/account/Barn_Owl/
- Matteson, S. and L. Petersen. 1988. Wisconsin Common Barn-Owl management plan. Wisconsin Endangered Resources Report No. 37, Wisconsin Department of Natural Resources, Madison.
- McClain, W. E. 1986. Illinois Prairie: Past and Future. Department of Conservation, Division of Natural Heritage, Springfield.
- Meadowlark: A Journal of Illinois Birds*. 1991 - 2008 (Vol. 1, Issue 1 – Vol. 18, Issue 2). Field Notes. Published by Illinois Ornithological Society.
- Mendenhall, V. M. and L. F. Park. 1980. Secondary poisoning of owls by anticoagulant rodenticides. *Wildlife Society Bulletin* 8:311-315.

- Michelat, D. and P. Giraudoux. 1991. Dimension du domaine vital de la Chouette effraie (*Tyto alba*) pendant la nidification. *Alauda* 59:137-142.
- Millsap, B. A. and P. A. Millsap. 1987. Burrow nesting by Common Barn Owls in north central Colorado. *Condor* 89:668-670.
- Missouri Department of Conservation. 2008. Status assessment of the barn owl (*Tyto alba*): proposed for state delisting September 2008.
- Mlodinow, S. 1984. Chicago Area Birds. Chicago Review Press, Chicago, Illinois.
- Muller, Y. 1981. Une chouette effraie (*Tyto alba*) se reproduit dès l'age de 7 mois. *Ciconia* 5:143-147.
- Mumford, R. E. and C. E. Keller. 1984. The Birds of Indiana. Indiana University Press, Bloomington.
- National Audubon Society. 2010. Christmas Bird Count. Historical Results.
<http://www.audubon.org/bird/cbc/hr/index.html>
- NatureServe.2009. NatureServe Explorer. <http://www.natureserve.org/explorer/>
- Newton, I., I. Wyllie, and A. Asher. 1991. Mortality causes in British Barn Owls *Tyto alba* with a discussion of aldrin. *Ibis* 133:162-169.
- Newton, I., I. Wyllie, and L. Dale. 1997. Mortality causes in British Barn Owls (*Tyto alba*), based on 1,101 carcasses examined during 1963-1996. Pages 299-307 in *Biology and conservation of owls in the northern hemisphere*. (J. R. Duncan, D. H. Johnson, and T. H. Nicholls, editors) U.S.D.A. Forest Serv. Gen. Tech. Rep. NC-190, St. Paul, Minnesota.
- Nuzzo, V. A. 1986. Extent and status of Midwest oak savanna: presettlement and 1985. *Natural Areas Journal* 6:6-26.

- Ohio Department of Natural Resources. 2009. Grassland Species Overview.
http://www.dnr.state.oh.us/Home/wild_resourcessubhomepage/ResearchandSurveys/WildlifePopulationStatusLandingPage/GrasslandSpeciesOverview/tabid/19337/Default.aspx
- Olson, S. L. 1985. The fossil record of birds. Pages 79-238 in Avian Biology. Vol. 8 (D. S. Farner, J. R. King, and K. C. Parkes, editors) Academic Press, Orlando, Florida.
- Ontario Barn Owl Recovery Team. 2009. Draft Recovery Strategy for the Barn Owl (*Tyto alba*) in Ontario. Ontario Recovery Strategy Series. Prepared for the Ontario Ministry of Natural Resources, Peterborough, Ontario.
- Peterjohn, B. G. 1989. The Birds of Ohio. Indiana University Press. Bloomington.
- Ramsden, D. J. 1998. Effect of barn conversions on local populations of Barn Owl *Tyto alba*. Bird Study 45:68-76.
- Ramsden, D. J. 2003. Barn owls and major roads; Results and recommendations from a 15-year research project. <http://www.barnowltrust.org.uk/Forms/WebsiteReport.pdf>
- Ridgway, R. 1914. The birds of North and Middle America. Bulletin of the U. S. National Museum Part IV. Washington, DC.
- Robinson, W. D. 1996. Southern Illinois Birds: an annotated list and site guide. Southern Illinois University Press, Carbondale.
- Rosenburg, C. P. 1986. Barn Owl habitat and prey use in agricultural eastern Virginia. M. S. Thesis. College of William and Mary, Williamsburg, Virginia.
- Sharrock, J.T.R. 1976. The atlas of breeding birds in Britain and Ireland. British Trust for Ornithology, England.
- Shiple, K. L., R. J. Gates, N. J. Stricker. 2008. Barn owl habitat models. 2008 Ohio Wildlife Research Report: 12-19. Ohio Department of Natural Resources, Division of Wildlife.

- Snow, D. W. and C. M. Perrins. 1998. The birds of the western Palearctic, non-passerines. Vol. 1. Oxford Univ. Press, Oxford, UK.
- Soucy, L. J. 1980. Three long distance recoveries of banded New Jersey Barn Owls. *North American Bird Bander* 5:97.
- Stewart, P. A. 1952. Dispersal, breeding behavior, and longevity of banded Barn Owls in North America. *Auk* 69:227-245.
- Stewart, P. A. 1980. Population trends of Barn Owls in North America. *American Birds* 34:698-700.
- Taylor, I. R. 1992. An assessment of the significance of annual variations in snow cover in determining short-term population changes in field voles *Microtus agrestis* and Barn Owls *Tyto alba* in Britain. Pages 32-38 in *The ecology and conservation of European owls*. (Galbraith, C. A., I. R. Taylor, and C. M. Percival, editors) Joint Nature Cons. Comm. Peterborough, UK.
- Taylor, I. R. 1994. *Barn Owls*. Cambridge University Press, Cambridge, UK.
- Taylor, I. R., A. Dowell, T. Irving, I. K. Langford, and G. Shaw. 1988. The distribution and abundance of the Barn Owl *Tyto alba* in south-west Scotland. *Scottish Birds* 15:40-43.
- U. S. Department of Agriculture 1950. The 1950 Census of Agriculture.
http://www.agcensus.usda.gov/Publications/Historical_Publications/index.asp
- U. S. Department of Agriculture 2007. The 2007 Census of Agriculture.
<http://www.agcensus.usda.gov/Publications/2007/index.asp>
- U. S. Department of Agriculture. 2010. National Agricultural Statistics Service.
<http://www.nass.usda.gov/>

Walk, J. W., T. L. Esker, and S. A. Simpson. 1999. Continuous nesting of Barn Owls in Illinois.

Wilson Bull. 111:572-573.

White, J. 1978. Illinois Natural Areas Inventory Technical Report. Volume 1. Illinois Natural

Areas Inventory, Urbana, and Illinois Department of Conservation, Springfield.

Appendix I. *Species in Greatest Need of Conservation* associated with barn owl habitat in Illinois. Includes first state-record and other rare insect species identified by Bouseman (1997) and LaGessee and Wiker (2008).

INSECTS

Amphipoea erepta	Papaipema birdi
Andrena rudbeckiae	Papaipema cerussata
Apamea indocilis (ignorant Apamea)	Papaipema eryngii (rattlesnake master borer moth)
Archana oblonga (oblong sedge borer moth)	Papaipema eupatorii (Eupatorium borer moth)
Basilodes pepita (gold moth)	Papaipema furcata
Bellura densa (pickerelweek borer moth)	Papaipema inquaesita (sensitive fern borer moth)
Bellura gortynoides (white-tailed diver moth)	Papaipema limpida (limpid borer moth)
Cicadetta calliope (small prairie cicada)	Papaipema maritima
Euphyes dukesi (Duke's skipper)	Papaipema nebris
Gabara subnivosella	Papaipema necopina (sunflower borer moth)
Lodopepla u-album	Papaipema rigida (rigid sunflower borer moth)
Macrosiagon dimidatum	Papaipema rutila (mayapple borer moth)
Macrosiagon limbatum	Papaipema silphii (Silphium borer moth)
Melissodes boltoniae	Parapamea buffaloensis (buffalo moth)
Melissodes coloradensis	Phytometra ernestinana (Erenstine's moth)
Melissodes comptoides	Problema byssus (byssus skipper)
Melissodes dentiventris	Pyrota mutata
Melissodes wheeleri	Schinia gaurae (clouded crimson)
Meropleon diversicolor	Schinia gracilentia
Meropleon titan	Schinia nundina
Nemognatha lurida	Tibicen dorsata (large prairie cicada)
Papaipema beeriana (Liatris borer moth)	Tricholita notata
	Vaxi auratella

Zonitis vittigera

AMPHIBIANS

Pseudacris streckeri illinoensis (Illinois chorus frog)

Rana areolata (crayfish frog)

REPTILES

Clonophis kirtlandii (Kirtland's snake)

Heterodon nasicus (western hognose snake)

Kinosternon flavescens (Illinois mud turtle)

Masticophis flagellum (coachwhip)

Liochlorophis vernalis (smooth green snake)

Ophisaurus attenuatus (slender glass lizard)

Sistrurus catenatus catenatus (eastern massasauga)

Terrapene ornata (ornate box turtle)

Tropidoclonion lineatum (lined snake)

BIRDS

Ammodramus henslowii (Henslow's sparrow)

Ammodramus leconteii (LeConte's sparrow)

Ammodramus nelsoni (Nelson's sharp-tailed sparrow)

Ammodramus savannarum (grasshopper sparrow)

Asio flammeus (short-eared owl)

Bartramia longicauda (upland sandpiper)

Buteo swainsoni (Swainson's hawk)

Calcarius pictus (Smith's longspur)

Chordeiles minor (common nighthawk)

Circus cyaneus (northern harrier)

Cistothorus platensis (sedge wren)

Coccyzus americanus (yellow-billed cuckoo)

Coccyzus erythrophthalmus (black-billed cuckoo)

Colaptes auratus (northern flicker)

Colinus virginianus (northern bobwhite)

Dendroica discolor (prairie warbler)

Dolichonyx oryzivorus (bobolink)

Empidonax trailli (willow flycatcher)

Icteria virens (yellow-breasted chat)

Lanius ludovicianus (loggerhead shrike)

Melanerpes erythrocephalus (red-headed woodpecker)

Passerculus sandwichensis (savannah sparrow)

Pluvialis dominica (American golden-plover)

Rallus elegans (king rail)

Scolopax minor (American woodcock)

Spiza americana (dickcissel)

Spizella pusilla (field sparrow)

Toxostoma rufum (brown thrasher)

Tympanuchus cupido (greater prairie-chicken)

Vireo belli (Bell's vireo)

MAMMALS

Mustela nivalis (least weasel)

Spermophilus franklinii (Franklin's ground-squirrel)

Taxidea taxus (American badger)

Appendix II. Guidance and suggested scoring of various factors affecting the feasibility and probability of success of barn owl conservation. Conservation actions in areas scoring ≥ 7 are most likely to benefit barn owls.

<p>Regional Climate</p>	<p>Barn owls are not cold-adapted, and adult barn owls remain near nest site through the winter. Extreme cold and prolonged snow cover can cause high barn owl mortality. In Illinois, climate suitability for barn owls improves from north to south (Fig. A1).</p> <p><i>Scoring based on mean daily January temperature:</i></p> <p>>30° F = 3 24-30° F = 2 18-24° F = 1 <18° F = 0</p>
<p>Regional Habitat Availability</p>	<p>The amount of foraging habitat is an important factor limiting the size of a regional barn owl population. We have ranked Illinois counties in quartiles, based on % cover of hay and idle grasslands (Fig. A2).</p> <p><i>Scoring based on % grassland in a county:</i></p> <p>7-15% = 3 5-7% = 2 3-5% = 1 0-3% = 0</p>
<p>Local Foraging Habitat Availability</p>	<p>The amount of foraging habitat (pasture, hay lands, and idle grasslands) within 1.6 km (1 mile) of a potential nest box site will approximate conditions within a typical barn owl home range. Wooded areas decrease the likelihood of barn owl occurrence. Areas with >1/3 foraging habitat and <1/3 forest cover are very good potential barn owl habitat.</p> <p><i>Scoring based on proportion of grassland and forest cover in 1.6 km (1 mile) radius:</i></p>

	<p>>1/3 grassland and <1/3 forest = 3</p> <p>>1/3 grassland and >1/3 forest = 2</p> <p><1/3 grassland and <1/3 forest = 1</p> <p><1/3 grassland and >1/3 forest = 0</p>
Nearby Barn Owl Occurrence	<p>Sites 3-16 km (2-10 miles) from nesting barn owls are good candidates for nest boxes. Barn owl occurrence is <i>de facto</i> evidence of suitable habitat in the region. Though barn owls disperse much greater distances, young birds may spend additional time searching for mates in areas they encounter a mated pair than in areas where they encounter no conspecifics. Nest boxes separated by >3 km are not likely to induce competition among pairs of barn owls.</p> <p><i>Scoring based on barn owl occurrence within 16 km (10 miles):</i></p> <p>Present = 1</p> <p>Absent/unknown = 0</p>
Roadway Mortality	<p>To reduce the risk of collisions with vehicles, locations within 1 km (0.6 mile) of interstate highways or other major roads, areas of high road density or heavy traffic are not recommended for barn owl nest boxes.</p> <p><i>Scoring based on proximity to major roads:</i></p> <p>>1km (0.6 mile) = 0</p> <p><1 km (0.6 mile) = -1</p>
Monitoring and Maintenance	<p>Nest boxes should be installed where they can be safely and regularly monitored and maintained. Consider distance from headquarters or regularly traveled routes, the need to carry ladders to nest boxes, etc.</p>
Disruption to Nesting	<p>Barn owls are tolerant of human activity, but nest boxes should be placed where fledglings will not face immediate hazards (mechanical devices, traffic, stored chemicals) upon leaving the nest. Because barn owls are an uncommon sight, the desire for people to see them is high. The locations of active nest sites should be revealed with discretion. All active nest sites should be reported to the Biotics 4 database.</p>

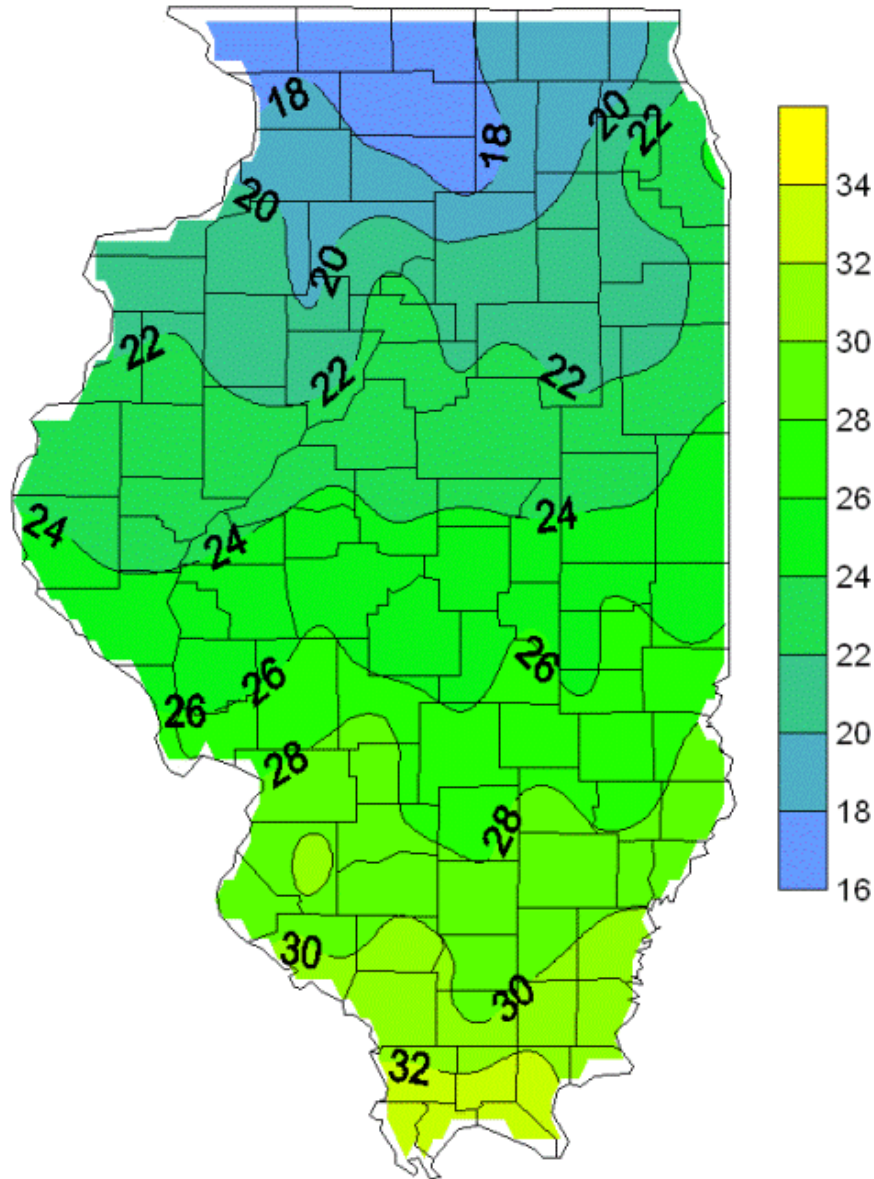

Fig. A1. Mean daily January temperature (°F) in Illinois, 1971-2000 (Illinois State Climatologist Office 2009). Conditions in northern Illinois likely place barn owls under high thermal stress and prolonged periods of snow cover make foraging more difficult for barn owls. Conditions in far southern Illinois likely cause low thermal stress, and snow cover seldom hinders foraging.

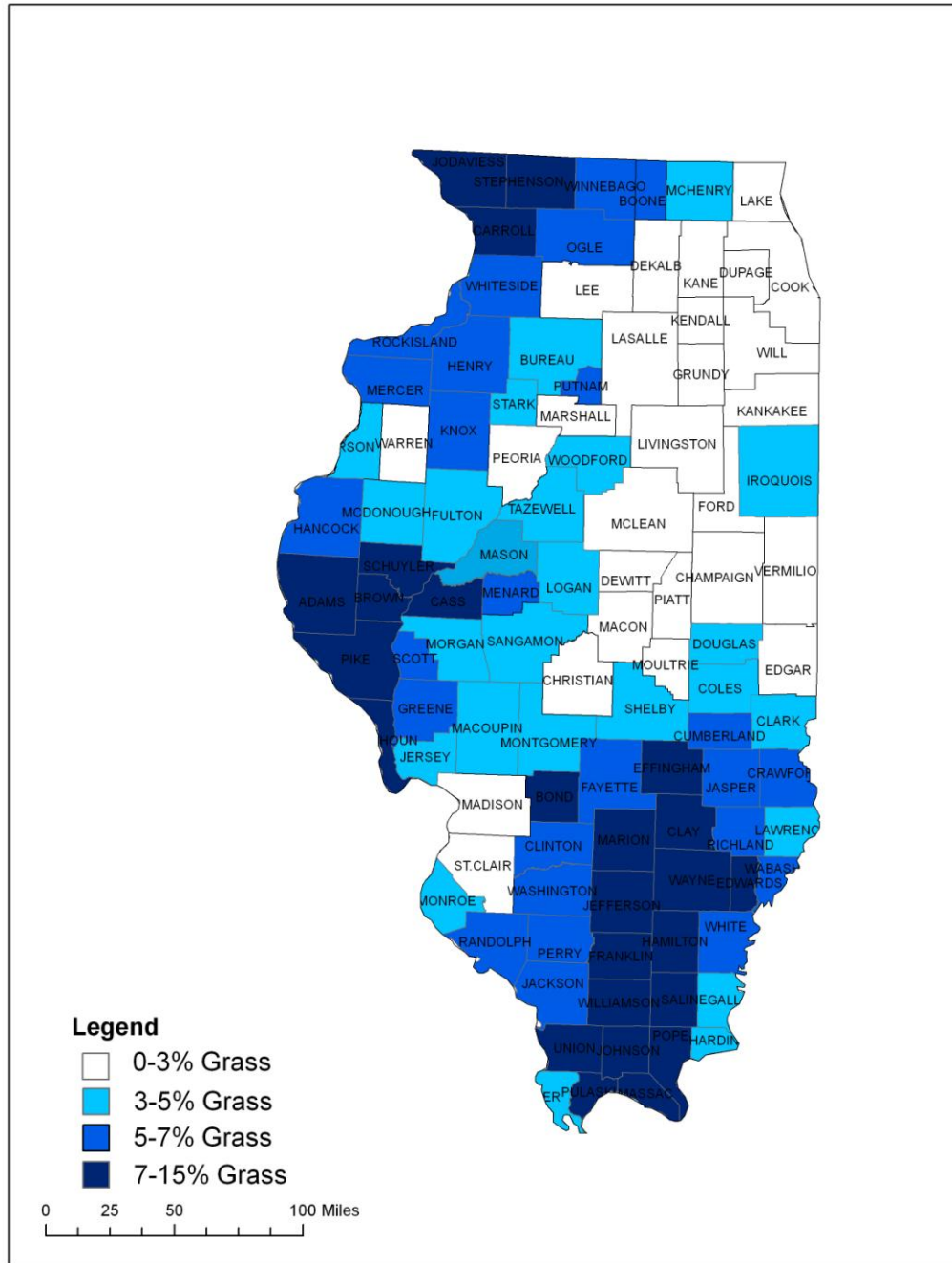

Fig. A2. An index of foraging habitat availability in Illinois counties in 2008 (combined percentage of hay and Conservation Reserve Program; U. S. Department of Agriculture 2010.), sorted by quartiles. The 25% most suitable counties have 7-15% foraging habitat. The 25% least suitable of counties have <3% foraging habitat.