

# TABLE OF CONTENTS

	PAGE
ARTICLE 3, NEW MINES – CERTIFICATES OF COMPETENCY- CREDENTIALS AND EXAMINATIONS	2
ARTICLE 7, HOISTING ENGINEER AND HOISTING	2
ARTICLE 8, MINERS’ EXAMINING BOARD AND MINERS’ EXAMINATIONS	5
MINING BOARD DECISION – NOVEMBER 4, 1975	5
MINE HOIST	7
HYDRAULIC SYSTEM	10
SHAFTS	14
CONVEYANCE	18
HEADFRAME	24
SHEAVES	28
BRAKES	33
CLUTCH	38
DRUM/WHEEL	43
WIRE ROPE	49
DEPTH INDICATOR	64
SAFETY CONTROLLER	68
CONTROL PANEL	71
COMMUNICATION SYSTEM	76
LUBRICATION	81
ELECTRICAL SYSTEM	86
INSPECTION	120
MAINTENANCE	123
BEGINNING OF SHIFT ACTIVITIES	126
ARTICLE 16, CAGES	136
ARTICLE 26, SHAFTS	137
LESSONS	140

(225 ILCS 705/Art. 3 heading)

ARTICLE 3.  
NEW MINES--CERTIFICATES OF  
COMPETENCY--CREDENTIALS AND EXAMINATIONS.

(225 ILCS 705/3.07) (from Ch. 96 1/2, par. 357)

Sec. 3.07. Each month the Department of Natural Resources shall prepare a list of those persons who have filed an application for any certificate of competency under this Act during the preceding 30 days, which list shall include the name of the applicant, the applicant's employer, the location of the applicant's employment and the type of certificate applied for. Such list shall be provided to each employer covered by this Act which shall be posted for a period of 30 days from its receipt in a conspicuous place available to all employees on the premises of the mine at which they are employed. The certificate of competency shall be considered temporary until this posting requirement at this place of employment has been completed. Nothing in this Section shall prohibit the holder of such temporary certificate from performing all of the functions that he is authorized to perform when such certification becomes permanent.

(Source: P.A. 89-445, eff. 2-7-96.)

(225 ILCS 705/Art. 7 heading)

ARTICLE 7.  
HOISTING ENGINEER AND HOISTING.

(225 ILCS 705/7.02) (from Ch. 96 1/2, par. 702)

Sec. 7.02. Each applicant for a certificate of competency as electrical hoisting engineer shall produce evidence satisfactory to the Mining Board that he is a citizen of the United States or lawfully admitted for permanent residence, at least 21 years of age, that he has had two years' experience with electrical hoisting equipment, or has completed a training course in operation and maintenance of electrical hoisting machinery approved by the Mining Board and is of good repute and temperate habits. He shall pass an examination as to his practical and technical knowledge of the construction of same, the care and adjustment of electrical hoisting engines, the management and efficiency of electric pumps, ropes and winding apparatus and as to his knowledge of the laws of this State in relation to signals and the hoisting and lowering of men at mines.

(Source: P.A. 101-541, eff. 8-23-19.)

(225 ILCS 705/7.03) (from Ch. 96 1/2, par. 703)

Sec. 7.03. It shall be unlawful for the operator of any mine to permit any person who does not hold a certificate of competency as hoisting engineer issued by the Mining Board to hoist or lower men, or to have charge of the hoisting engine when men are underground. No certified engineer shall be required for automatically operated cages or platforms. Provided, at any slope mine where the angle of the slope is not more than twenty degrees and men are not lowered into and/or hoisted out of the mine by hoisting equipment, and there is ample room in the slope and it would be practicable in the event of an accident to remove an injured person from the mine, no hoisting engineer holding a certificate of competency issued by the Mining Board shall be required.

(Source: Laws 1957, p. 2413.)

(225 ILCS 705/7.04) (from Ch. 96 1/2, par. 704)

Sec. 7.04. The Mining Board may grant a permit to operate a second motion engine, or internal combustion engine, at any mine employing not more than 10 men, to any person recommended to the Mining Board by the State Mine Inspector of the district. The applicant for such permit shall have filed with the Mining Board satisfactory evidence that he is a citizen of the United States or lawfully admitted for permanent residence, that he has had at least one year of experience in operating a steam engine, steam boiler, or internal combustion engine and understands the handling and care of the same. Such application shall be accompanied by a statement from at least three persons who will testify from their personal knowledge of the applicant that he is a man of good repute and personal habits, and that he has, in their judgment, a knowledge of and experience in

handling boilers and engines as required in this section. Such permit shall apply only to the mine for which it was issued, and for a period not to exceed one year, except such permit, when it expires, may be renewed by the Mining Board from year to year if the person holding same requests renewal, and certifies by sworn statement that all the circumstances and conditions are the same as when said permit was originally issued. (Source: P.A. 101-541, eff. 8-23-19.)

(225 ILCS 705/7.05) (from Ch. 96 1/2, par. 705)

Sec. 7.05. The certificate of any hoisting engineer may be cancelled and revoked by the Mining Board upon notice and hearing as hereinafter provided, if it shall be established in the judgment of said Mining Board that the holder thereof has obtained said certificate by fraud or misrepresentation of his experience or has become unworthy to hold said certificate by reason of violation of the law, intemperate habits, incapacity, abuse of authority or for any other cause. However, any person against whom charges or complaints are made hereunder shall have the right to appear before the Mining Board and defend himself against said charges, and he shall have 15 days' notice in writing of such charges previous to such hearing. The Mining Board, in its discretion, may suspend the certificate of any person charged as aforesaid, pending such hearing, but said hearing shall not be unreasonably deferred. (Source: Laws 1953, p. 701.)

(225 ILCS 705/7.06) (from Ch. 96 1/2, par. 706)

Sec. 7.06. Whenever the hoisting or lowering of men occurs before daylight or after dark, or when the landing at which men take or leave the cage is at all obscured by steam or otherwise, there must always be maintained at such landing a light sufficient to show the landing and surrounding objects distinctly. Likewise, as long as there are men underground in any mine the operator shall maintain a good and sufficient light at the bottom of the shaft thereof, so that persons coming to the bottom may clearly discern the cage and objects in the vicinity. (Source: Laws 1953, p. 701.)

(225 ILCS 705/7.07) (from Ch. 96 1/2, par. 707)

Sec. 7.07. In connection with every hoisting engine used for hoisting or lowering of men there shall be provided a good and sufficient brake on the drum, so adjusted that it may be operated by the engineer without leaving his post at the levers. (Source: Laws 1953, p. 701.)

(225 ILCS 705/7.08) (from Ch. 96 1/2, par. 708)

Sec. 7.08. Every hoisting drum shall be provided with flanges attached to the sides of the drum, with a distance when the whole rope is wound on the drum of not less than 4 inches between the outer layer of rope and the greatest diameter of the flange. (Source: Laws 1953, p. 701.)

(225 ILCS 705/7.09) (from Ch. 96 1/2, par. 709)

Sec. 7.09. One end of each hoisting rope shall be well secured on the drum, and at least three laps of the same shall remain on the drum when the cage is at rest at the lowest caging place in the shaft. The lower end of each rope shall be securely fastened to the cage by suitable clamps or sockets and chains. (Source: Laws 1953, p. 701.)

(225 ILCS 705/7.10) (from Ch. 96 1/2, par. 710)

Sec. 7.10. An index dial or indicator that plainly shows the engineer at all times the true position of the cages in the shaft shall be placed in clear view of the engineer. (Source: Laws 1953, p. 701.)

(225 ILCS 705/7.11) (from Ch. 96 1/2, par. 711)

Sec. 7.11. At the beginning of each shift and after the mine has been idle, the hoisting engineer shall operate the cages up and down the shaft at least one round trip

before hoisting or lowering men. A similar procedure shall be following in slope mines, except that an attendant may ride the trip.

(Source: Laws 1953, p. 701.)

(225 ILCS 705/7.12) (from Ch. 96 1/2, par. 712)

Sec. 7.12. At every mine where men are hoisted and lowered by machinery there shall be provided means of signaling to and from the bottom man, the top man and the engineer. The signal system shall consist of a tube, or tubes, or wire encased in wood or iron pipes, through which signals shall be communicated by electricity, compressed air or other pneumatic devices or by ringing a bell. When compressed air or other pneumatic devices are used for signaling, provision must be made to prevent signal from repeating or reversing.

(Source: Laws 1953, p. 701.)

(225 ILCS 705/7.13) (from Ch. 96 1/2, par. 713)

Sec. 7.13. The following signals shall be used at all the mines.

1. From the bottom to the top: One ring or whistle shall signify to hoist coal or the empty cage, and also to stop either when in motion.

2. Two rings or whistles shall signify to lower cage.

3. Three rings or whistles shall signify that men are coming up or going down; when return signal is received from the engineer the men shall get on the cage and the proper signal to hoist or lower shall be given.

4. Four rings or whistles shall signify to hoist slowly, implying danger.

5. Five rings or whistles shall signify accident in the mine and a call for a stretcher.

6. Six rings or whistles shall signify hold cage perfectly still until signaled otherwise.

7. From top to bottom, one ring or whistle shall signify: All ready, get on cage.

8. Two rings or whistles shall signify: Send away empty cage.

However, the operator of any mine may, with the consent of the State Mine Inspector, add to the code of signals. The code of signals in use at any mine shall be conspicuously posted at the top and at the bottom of the shaft, and in the engine room at some point in front of the engineer when standing at his post.

(Source: Laws 1953, p. 701.)

(225 ILCS 705/7.14) (from Ch. 96 1/2, par. 714)

Sec. 7.14. Where a hoisting engineer is required by law, he shall:

1. Be in constant attendance at his engine, or boilers, at all times when there are workers underground. When it is the duty of the engineer to attend to the boilers, means for signaling from the shaft bottom to the boiler room shall be provided.

2. Not permit anyone except duly authorized persons to enter the engine room; nor converse with any person while his engine is in operation, or while his attention is occupied with the signals.

3. Thoroughly understand the established code of signals, and when he has the signal that men are on the cage he shall not operate his engine to exceed the rate of speed provided in Section 7.18 except as permitted by the State Mine Inspector.

4. Not permit anyone to handle, except in the official discharge of duty, any machinery under his charge; nor permit anyone who is not a certified engineer to operate his engine, except for the purpose of teaching an apprentice to operate the engine, and then only in his presence and when men are not on the cage.

(Source: P.A. 81-992.)

(225 ILCS 705/7.15) (from Ch. 96 1/2, par. 715)

Sec. 7.15. The hoisting engineer or some other properly authorized employee shall:

1. Keep a careful watch over the engines, boilers, pumps, ropes, and winding apparatus.

2. Be certain the boilers are properly supplied with water, cleaned, and inspected at frequent intervals.

3. Be certain the steam pressure does not exceed the limit established by the boiler inspector, frequently open the try cocks and the safety valves, and not increase the

weights on the safety valves.

4. Be certain the steam and water gauges are kept in good order. If any of the pumps, valves, or gauges become deranged or fail to act he shall immediately report the fact to the proper authorities.

5. Make a daily inspection of the hoisting equipment.  
(Source: Laws 1953, p. 701.)

(225 ILCS 705/7.16) (from Ch. 96 1/2, par. 716)

Sec. 7.16. No person shall handle or disturb any part of the hoisting machinery without proper authority.  
(Source: Laws 1953, p. 701.)

(225 ILCS 705/7.17) (from Ch. 96 1/2, par. 717)

Sec. 7.17. At every shaft where men are hoisted or lowered by machinery, the operator shall station a competent man at the top and at the bottom of the shaft who shall attend to signals, and be empowered to preserve order and enforce the rules governing the carriage of men on cages. The top man and bottom man shall be at their respective posts of duty a sufficient length of time before hoisting of coal begins in the morning and after the hoisting of coal ceases for the day, to properly perform their duties as provided for in this Section.  
(Source: Laws 1953, p. 701.)

(225 ILCS 705/7.18) (from Ch. 96 1/2, par. 718)

Sec. 7.18. Cages on which men are riding shall not be lifted nor lowered at a rate of speed greater than 600 feet per minute, except with the written consent of the State Mine Inspector. No person shall carry any tools, timber or other materials with him on any cage in motion, except for use in repairing the shaft and no one shall ride on a cage containing either a loaded or empty car.  
(Source: Laws 1953, p. 701.)

(225 ILCS 705/Art. 8 heading)

ARTICLE 8.

MINERS' EXAMINING BOARD AND MINERS' EXAMINATIONS.

(225 ILCS 705/8.21) (from Ch. 96 1/2, par. 821)

Sec. 8.21. Any person who applies for a certificate of competency provided in this Article shall cause to be posted in a conspicuous place available to all employees on the premises of the mine at which he is employed a copy of his application for such certificate. The employer of such persons shall provide a suitable location for such posting. The application shall be posted for a period of 30 days from the date of such application. This posting requirement shall be in addition to the requirements of Section 3.07 of this Act which shall apply fully to certificates applied for and issued under this Article.  
(Source: P.A. 85-1333.)

MINING BOARD DECISION ADOPTED ON NOVEMBER 4, 1975.

AT NATIONAL GUARD ARMORY, WEST FRANKFORT, ILLINOIS.

Within 90 calendar days of notification that he/she has passed the examination, each applicant for certification as Hoisting Engineer to learn the arts necessary and associated with the operation of a hoist. As evidence he/she shall keep a logbook, which shall be signed by an actively employed certified Hoisting

Engineer, or a letter signed by the mine superintendent or other person who is actively employed as a Hoisting Engineer. A letter signed by a person working on a Temporary Hoisting Permit will not be acceptable in this instance.

In second motion engines, he/she must in addition attend a school of instruction supplied by the State Department of Mines and Minerals. The certificate for second motion engines shall be separate from the certificate issued for permanent stationary hoists at coal-producing mines. A candidate for Stationary Hoisting Engineer, and the logbook must be signed by the certified Hoisting Engineer or a letter by a responsible superintendent who has Illinois Certification as Hoisting Engineer.

Each candidate's performance shall be witnessed by two (2) State Mine Inspectors and they shall submit a document to the Department so stating before a certificate of competency will be issued.

After April 27 and 28, 1976, and May 13 and 14, 1976, persons seeking certification as Hoisting Engineers must supply evidence of the above requirements for practical experience before being entitled to take the written examination.

# MINE HOIST OPERATOR TRAINING SYSTEM

## UNIT

## MINE HOIST

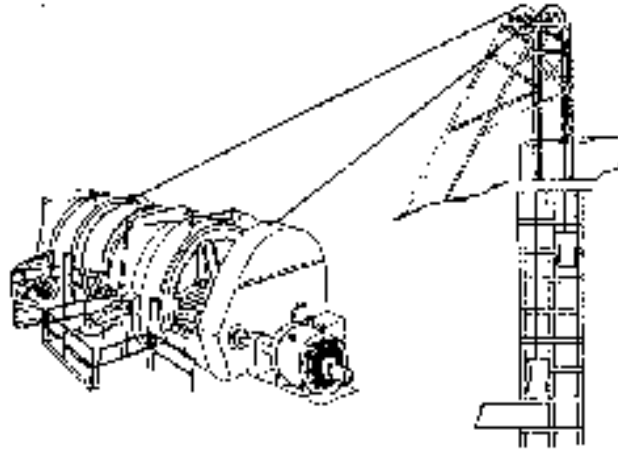

## OBJECTIVE

The trainee will know the major components for the hoist.

## TIME

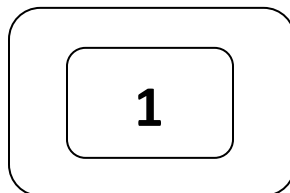

## **INSTRUCTIONAL OBJECTIVES FOR THE MINE HOIST**

The trainee will be able to write in one or two sentences the function (use) of the mine hoist.

The trainee will be able to identify parts of the mine hoist.

Given an illustration of a mine hoist where each of the parts is labeled with a letter, the trainee will be able to:

1. Write the name of each labeled part
2. Match each lettered part to a sentence that explains it.



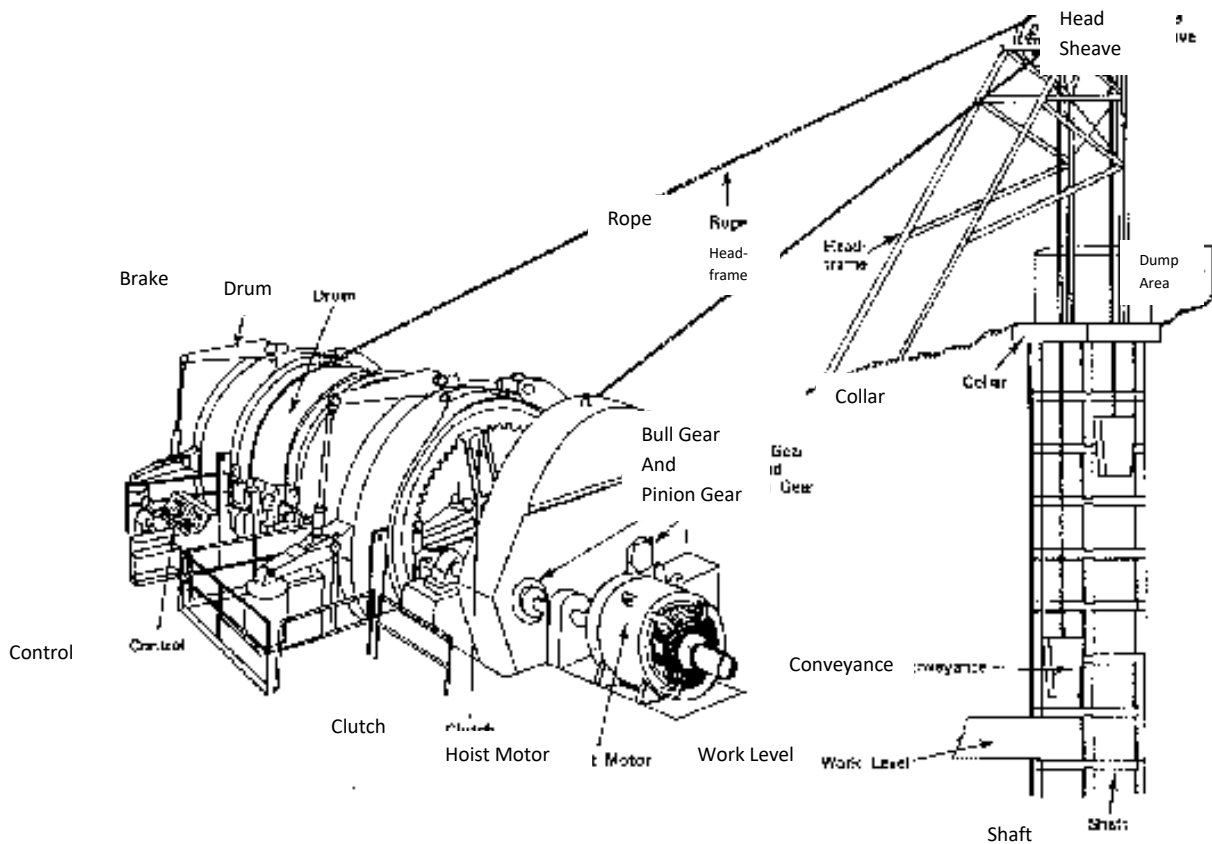

The MINE HOIST lowers men and materials into the mine and raises men, materials, ore and waste out of the mine.

The principle parts of the hoist are:

- **MINE SHAFT**- The path from the surface to the underground workings;
- **COLLAR**- The area surrounding the surface opening of the shaft;
- **DUMP AREA**- The area where ore and waste are deposited;
- **WORK LEVEL**- The mine level from which ore or waste is being hoisted;
- **CONVEYANCE**- The platform on which men, materials, ore and waste are hoisted/lowered;
- **HEADFRAME**- The structure which holds the head sheave;
- **HEAD SHEAVE**- The grooved wheel which supports the rope;
- **HOIST ROPE**- The wire cable which raises and lowers the hoist rope;
- **HOIST DRUM** or **WHEEL**- The drum or wheel which raises and lowers the hoist rope;
- **HOIST MOTOR**- The motor which turns the hoist drum or wheel;
- **PINION** and **BULL GEARS**- Gears which connect the hoist motor to the hoist drum or hoist wheel;
- **CLUTCH**- The device which engages or disengages the drum from the hoist motor;
- **BRAKE**- The device which slows, stops and holds the hoist rope;
- **CONTROL**- The station from which the hoist is operated.

# MINE HOIST OPERATOR TRAINING SYSTEM

## UNIT

## HYDRAULIC SYSTEM

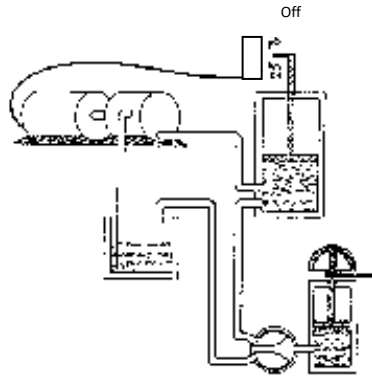

## OBJECTIVE

The trainee will know the operating principles and major components of the hydraulic system.

## TIME

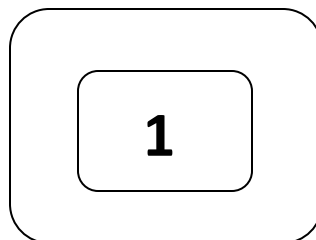

## **INSTRUCTIONAL OBJECTIVES FOR THE HYDRAULIC SYSTEM**

The trainee will be able to state in one or two sentences the function (use) of the hydraulic system.

The trainee will be able to identify the parts of the hydraulic system.

Given an illustration of the hydraulic system where each part is labeled with a letter, the trainee will be able to:

1. Write the name of each labeled part;
2. Match each lettered part to a sentence that explains it.

The trainee will be able to explain the operating principles of the hydraulic system.

Given a passage explaining how the hydraulic system works, where some of the steps have blanks, the trainee will be able to fill in these blanks.

A Hydraulic System enables the hoist operator to apply or release the hoist brakes and to engage or disengage the clutch. These operations can be performed from a remote station with little effort from the operator. Controls cause oil under high pressure to force a piston or other mechanism to move and perform the desired work.

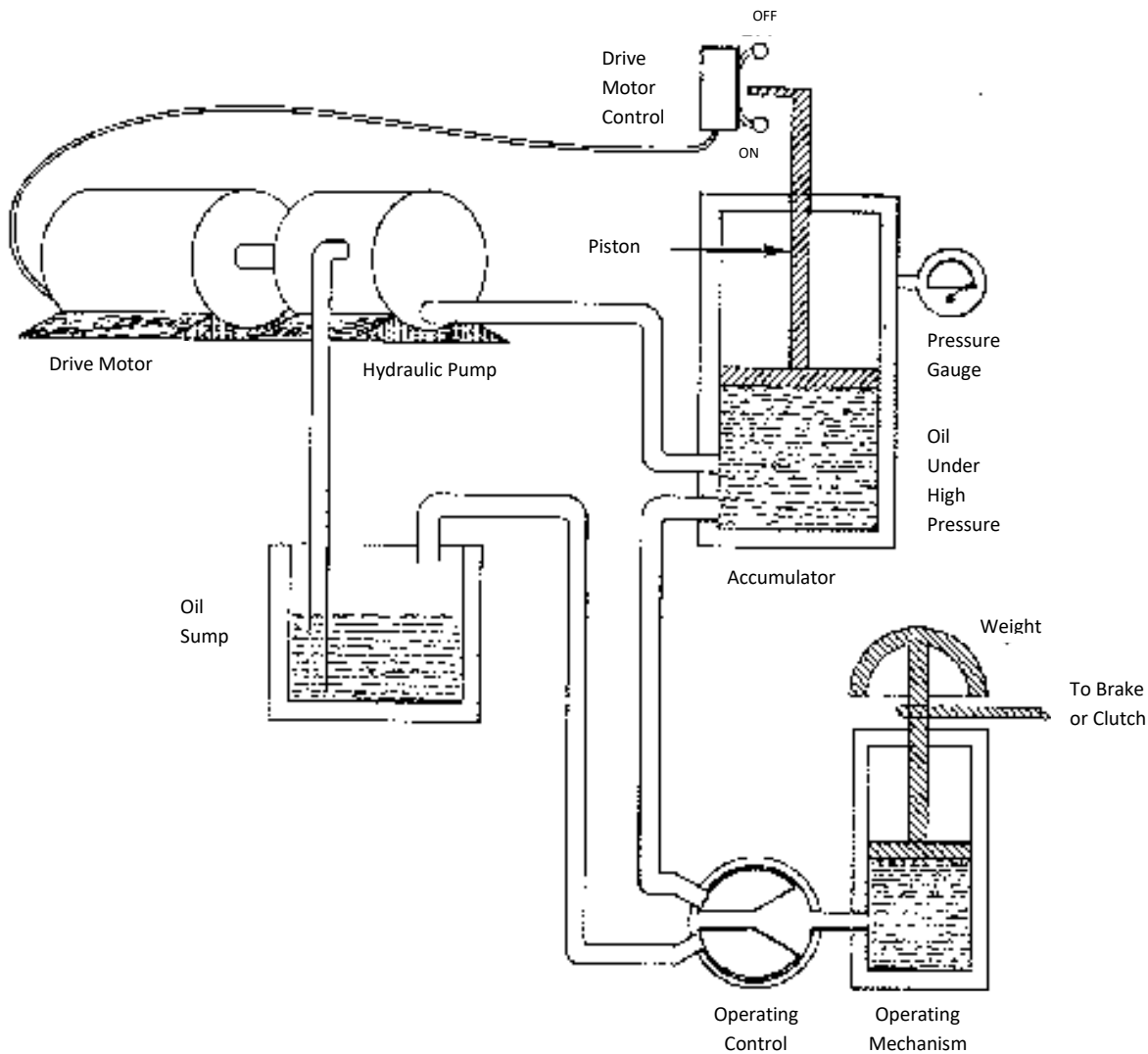

A basic hydraulic system consists of these parts:

- A hydraulic Pump that will pressurize oil.
- An electric Drive Motor that operates the pump.
- A Drive Motor Control that will start and stop the drive motor.
- An Accumulator that will store oil at high pressure. The accumulator is usually a cylinder and piston. Oil at high pressure is stored beneath the piston. The space above the piston may be filled with pressurized air to force the piston downward against the oil. Sometimes coiled springs or weights instead of high pressure air are used to force the piston against the oil.
- An Operating Control which the operator uses to control the flow of oil in the system.
- A Sump that stores oil at low pressure.
- An Operating Mechanism, usually a cylinder and piston, which does the work. This mechanism may apply or release the brake, or engage or disengage the clutch. If oil flows from the accumulator to the operating mechanism, the piston moves upward, lifts the weight and moves levers in one direction. If the oil flows from the operating mechanism to the sump, the piston moves downward because of the weight, and the levers move in the opposite direction.

The system works as follows:

- Using the operating control, the operator allows oil to flow from the accumulator into the operating mechanism.
- The piston moves upward and may for example, engage the clutch.
- When the operator wants to disengage the clutch, he/she again uses the operating control. Oil is allowed to flow from the operating mechanism to the sump.
- The piston in the operating mechanism will move downward because of the weight.
- As oil flows out of the accumulator, the accumulator piston moves downward. This movement causes the drive motor control to start the drive motor.
- The drive motor operates the pump which pumps oil from the sump to the accumulator.
- This increase in oil raises the accumulator piston
- When sufficient oil has been pumped, the upward movement of the accumulator piston shut off the drive motor.

# MINE HOIST OPERATOR TRAINING SYSTEM

## UNIT

# SHAFT

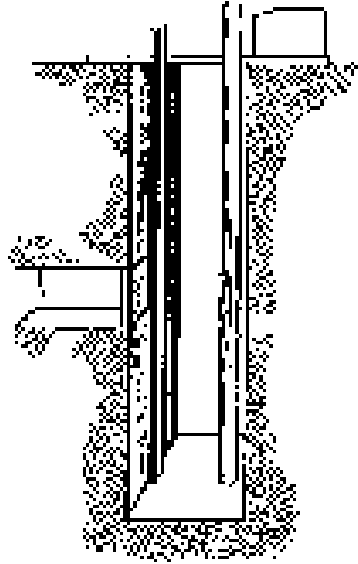

## OBJECTIVE

The trainee will know the major components and STATE regulations for the shaft.

## TIME

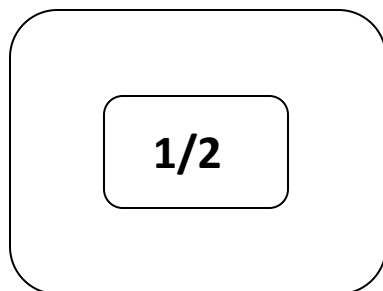

## **INSTRUCTIONAL OBJECTIVES FOR THE SHAFT**

The trainee will be able to answer multiple-choice questions concerning the function (use) of shafts.

The trainee will be able to identify the parts of a shaft.

Given an illustration of a shaft where each of the parts is labeled with a letter, the trainee will be able to:

1. Write the name of each labeled part;
2. Match each lettered part to a sentence that explains it.

The trainee will be able to answer multiple-choice questions concerning the application of State Regulations for the shafts.

The Shaft provides a path for one or more conveyance, power cables, and communication and other control links. There are two types of shafts: Vertical and Slope.

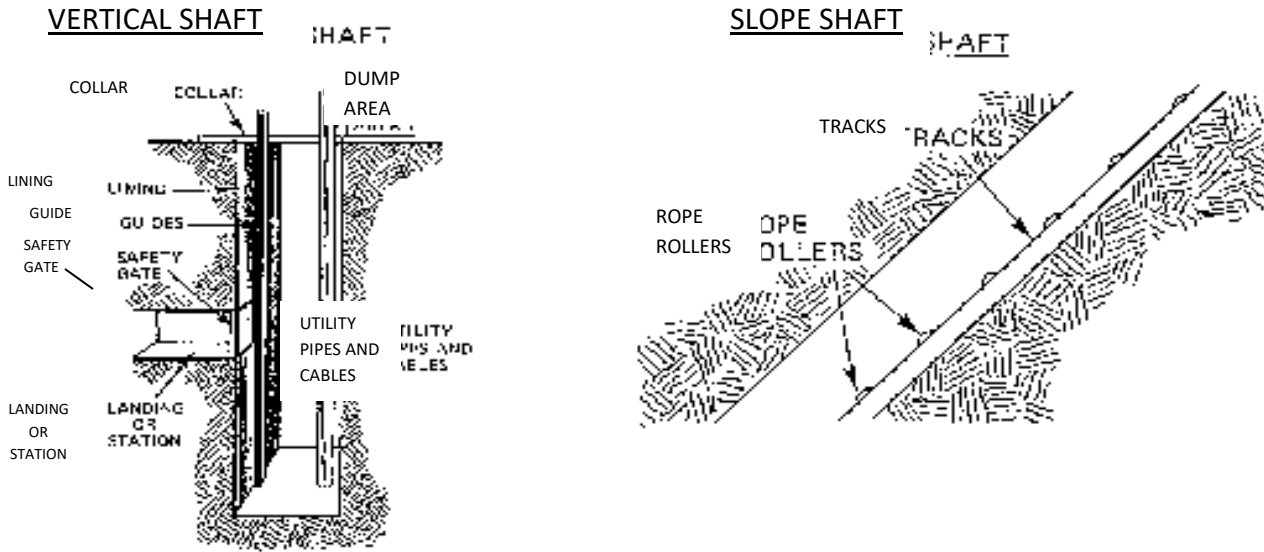

A shaft may be divided into Compartments. Each compartment provides a path for conveyance, counter weight, cables or other mine equipment.

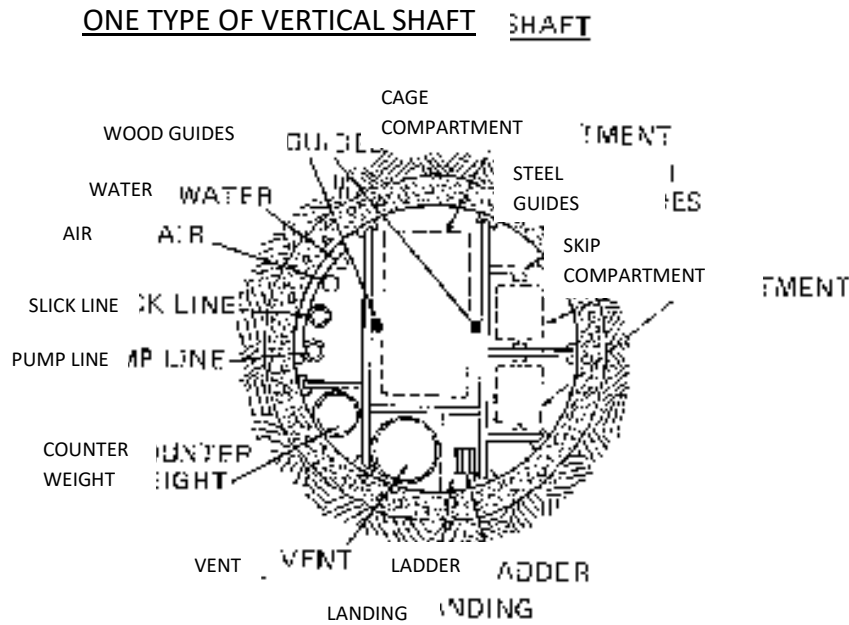



The Collar is the area surrounding the shaft opening at the face of the mine.

The Shaft Lining is the sides of the shaft. It is made of timber, steel or cement.

Shaft Guides keep the conveyance in proper position. Vertical shafts have fixed guides made of wood timber or steel rails or rope guides of locked coil ropes. Slope shafts have tracks to guide the conveyance and rollers to guide the rope.

A Landing or Station is the opening level onto the shaft.

A Safety Gate is the guard across a landing of the shaft.

The Dump is the area where the conveyance empties its load of coal or ore.

Utility Pipes and Cables are the paths for power, water, air and communications. They enter the mine through the shaft.

# MINE HOIST OPERATOR TRAINING SYSTEM

## UNIT

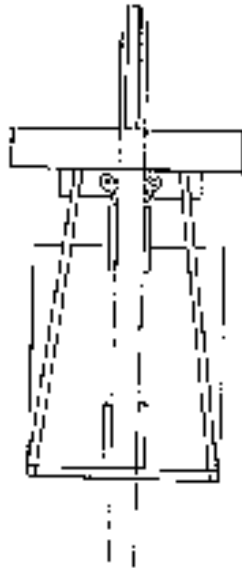

## CONVEYANCES

### OBJECTIVE

The trainee will know the major components and STATE regulations for the conveyance.

### TIME

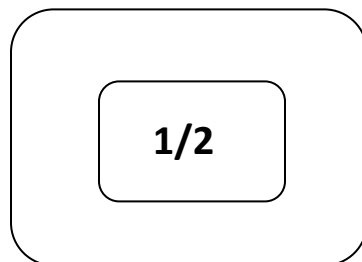

## **INSTRUCTIONAL OBJECTIVES FOR CONVEYANCES**

The trainee will be able to answer, in writing, multiple-choice questions about the functions (uses) of the different conveyances.

The trainee will be able to identify the types of conveyances. Given illustrations of the different types of conveyance, the trainee will be able to write skip, cage, or car for each conveyance.

The trainee will be able to identify, in writing, the parts of a skip and a cage:

1. Given illustrations of a skip and a cage, where each part is labeled with a letter, the trainee will be able to write the name of each lettered part.
2. The trainee will be able to answer, in writing, multiple-choice questions about the functions (uses) of the conveyance parts.

The trainee will be able to answer, in writing, multiple-choice questions concerning the State Regulations for the conveyance.

## CONVEYANCES

A conveyance is a platform that carries men and equipment to the working levels of the mine, and carries men, equipment and ore and muck to the surface.

In a shaft mine there are two basic kinds of conveyance:

1. Cage-to carry men and equipment.
2. Skip- to carry ore, waste, and certain heavy equipment.

The parts of a cage are: (See Figure 1)

The man compartment is the protected enclosure that the men ride in.

The bonnet protects the man compartment from falling objects.

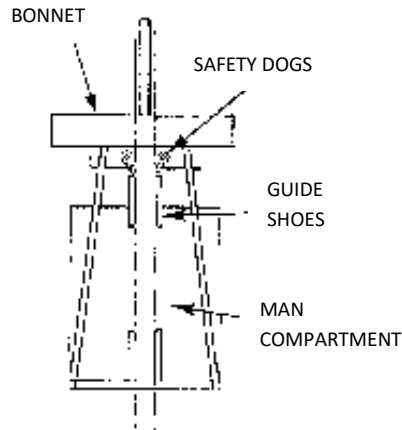

Figure 1

The safety dog is an emergency braking device that is attached to the conveyance. A typical safety dog is shown in Figure 2.

The safety dog is activated by a spring if slack appears in the hoist rope. When activated, the safety dog digs into the shaft guides, bringing the conveyance to a stop.

The guide shoe is the part of the conveyance that travels along the shaft guide. The guide shoe prevents the conveyance from moving horizontally in the shaft.

A skip is designed to dump its contents by:

- Turning upside down, or
- Opening its bottom or lower side

are: (See Figure 3)

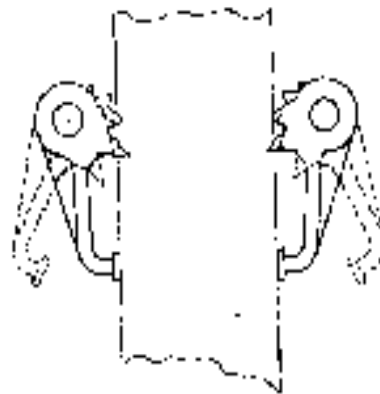

Figure 2

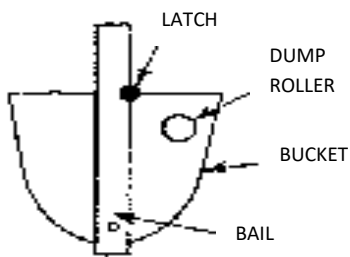
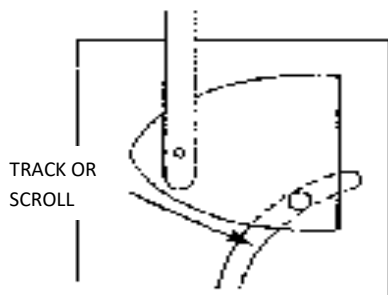

Figure 3



The dump roller is a wheel or roller mounted on the side of the conveyance.

The bail is the framework that supports the skip.

The bucket is the container for the ore, waste or heavy equipment.

The latch holds the skip upright.

The track or scroll engages the dump roller and dumps the skip.

A skip that dumps its contents by opening its bottom or lower side is called a bottom-dump skip. The part of a bottom-dump skip is: (See Figure 4)

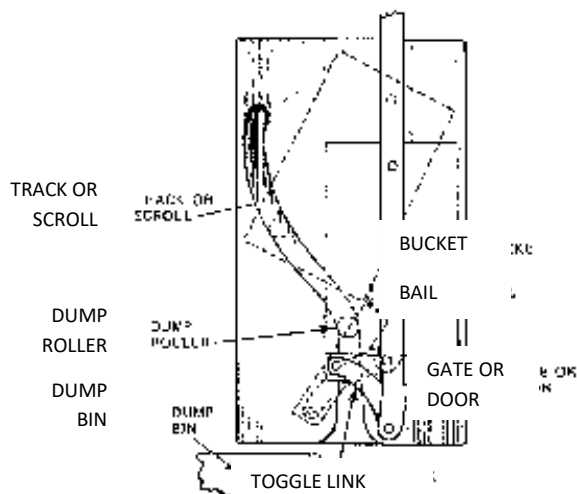

Figure 4

The gate or door is the side or bottom that opens to let ore out.

The actuating mechanism is the linkage that causes the gate to open. It includes the dump roller, and the track or scroll.

The bail is the framework that supports the skip.

The bucket is the container for the ore, waste or heavy equipment.

The safety latch is the device which prevents the gate from opening accidentally. It is actuated by the toggle link as the dump roller enters the scroll.

As the skip nears the dump point, the dump roller follows along a track or scroll. The shape of the track or scroll causes the roller to move horizontally and turn the skip upside down or open the skip dump gates.

Some conveyances are combinations of a skip and a cake. These combinations may look like: (See Figure 5)

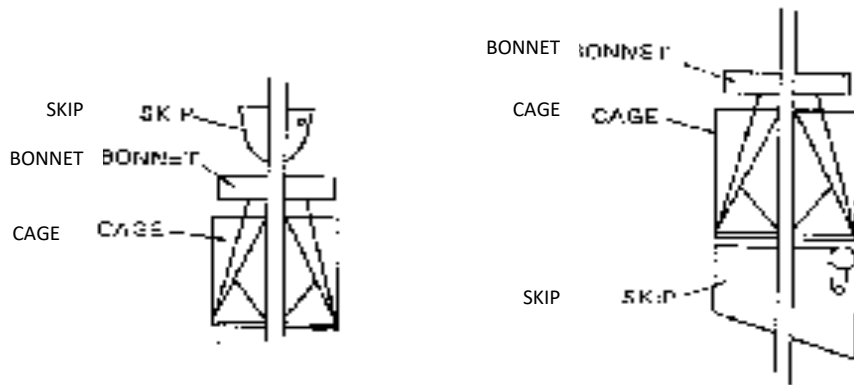
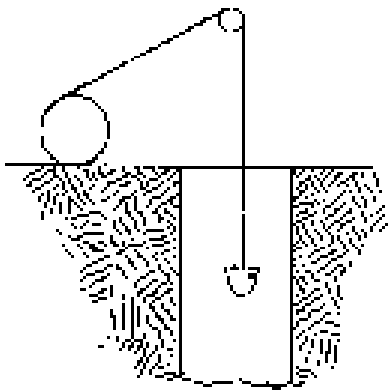

Figure 5

A vertical shaft hoist may have:

- A single rope and single conveyance. (See Figure 6)
- Two ropes with a conveyance and a counterweight. (See Figure 7)
- Two ropes with two conveyances. (See Figure 8)



SKIP

Figure 6

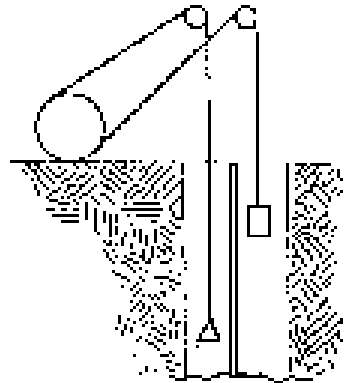

SKIP-COUNTERWEIGHT

Figure 7

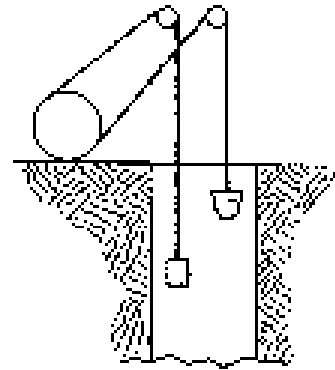

SKIP-CAGE

Figure 8

A tail-rope may be connected to the bottom of the conveyances or conveyance and counterweight to balance the weight of the hoist rope. (See Figure 9)

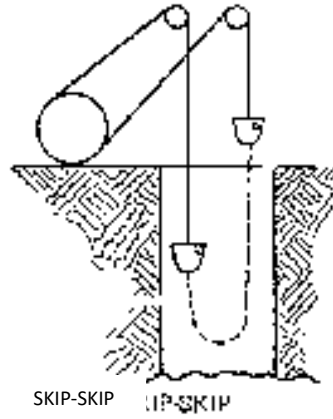

SKIP-SKIP

Figure 9

In a slope mine there are also two basic kinds of conveyance:

1. Man Cars- To carry men and equipment. Man cars are fitted with seats.
2. Ore Cars- To carry ore, waste, and some heavy equipment. Ore cars can be dumped by turning them upside down or by opening the bottom (See Figure 10)



Figure 10

Safety dogs are provided to stop the car if the rope breaks or goes slack. The dogs are forced into the ground by a spring. Magnetic brake cars may also be used to stop the man car if the rope breaks. They are down slope from the man car and apply breaks through magnets.

# MINE HOIST OPERATOR TRAINING SYSTEM

**UNIT**

**HEADFRAME**

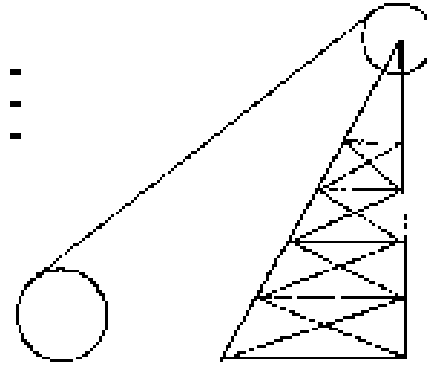

**OBJECTIVE:**

The trainee will know the major components and STATE regulations for the headframe.

**TIME**

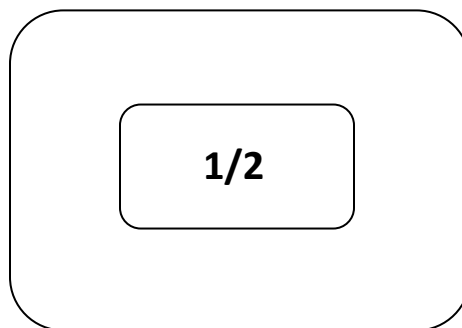



## **INSTRUCTIONAL OBJECTIVES FOR THE HEADFRAME**

The trainee will be able to state in one or two sentences the function (use) of head frames.

The trainee will be able to identify a head frame and related mine parts.

Given an illustration of a slope or vertical shaft in operation where each part is labeled with a letter, the trainee will be able to write the name of each lettered part.

The trainee will be able to describe fleet angle.

The trainee will be able to answer multiple-choice questions concerning the:

1. Definition of fleet angle:
2. Correct fleet angle:
3. Result of an incorrect fleet angle:

The trainee will be able to answer multiple-choice questions concerning the state regulations for head frames.

The Head frame supports the head sheave or head (Koepe) wheel over a shaft.

The head frame for a drum hoist holds a head sheave which supports the hoist rope.

In a vertical shaft it looks like this:

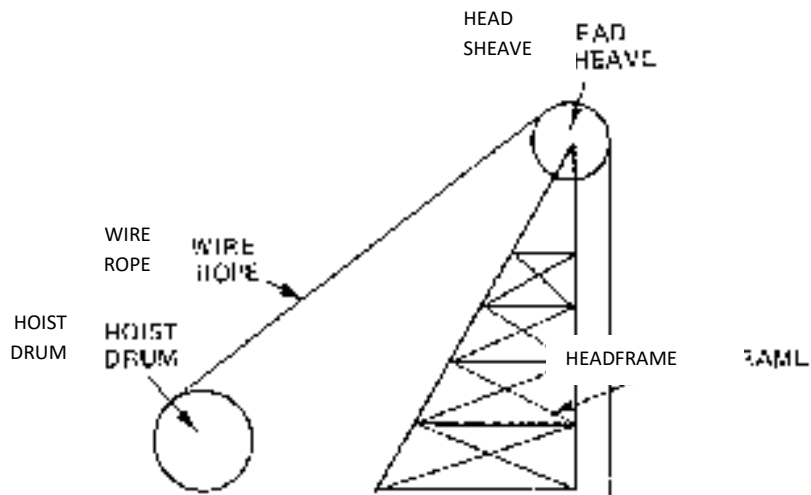

In a slope shaft an idler sheave and support replace the head sheave and head frame.

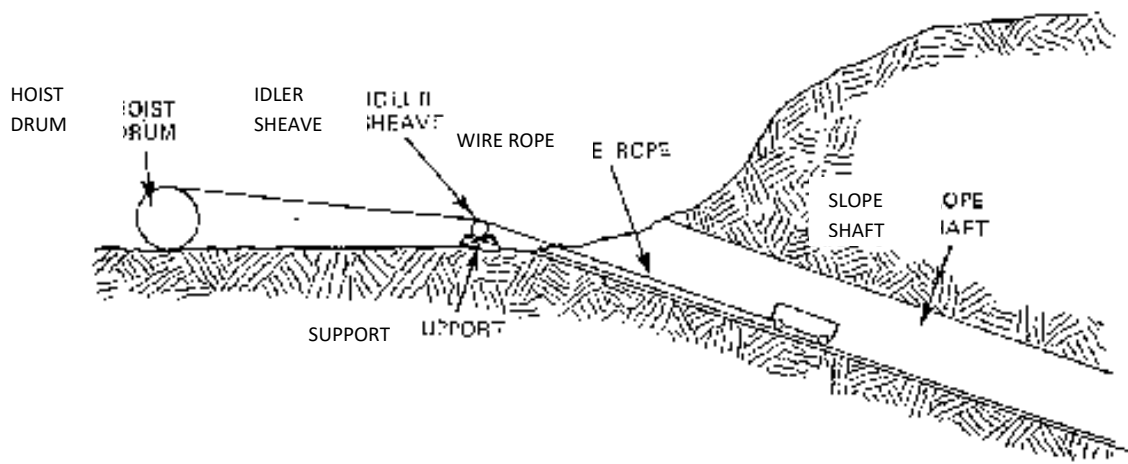

The angle between the center line of the sheave and the hoist rope is called the Fleet Angle. The fleet angle must not be more than 1 ½ degrees for smooth drums or 2 degrees for grooved drums or excessive wear on the rope will result.

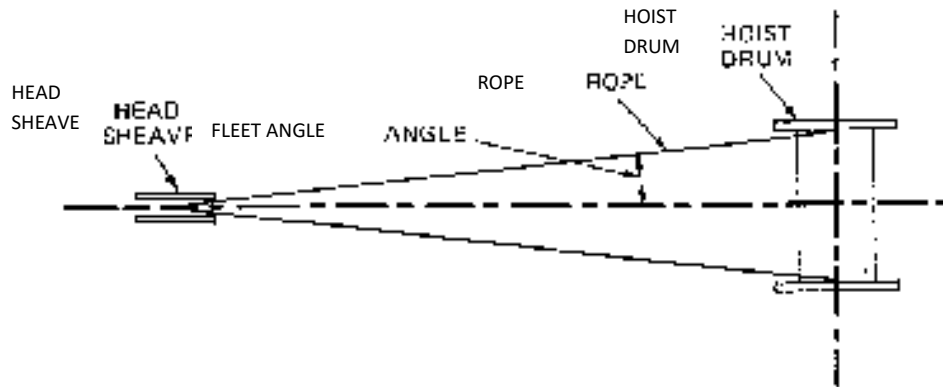

The Head frame for a Koepe or friction hoist may support the wheel and drive motor.

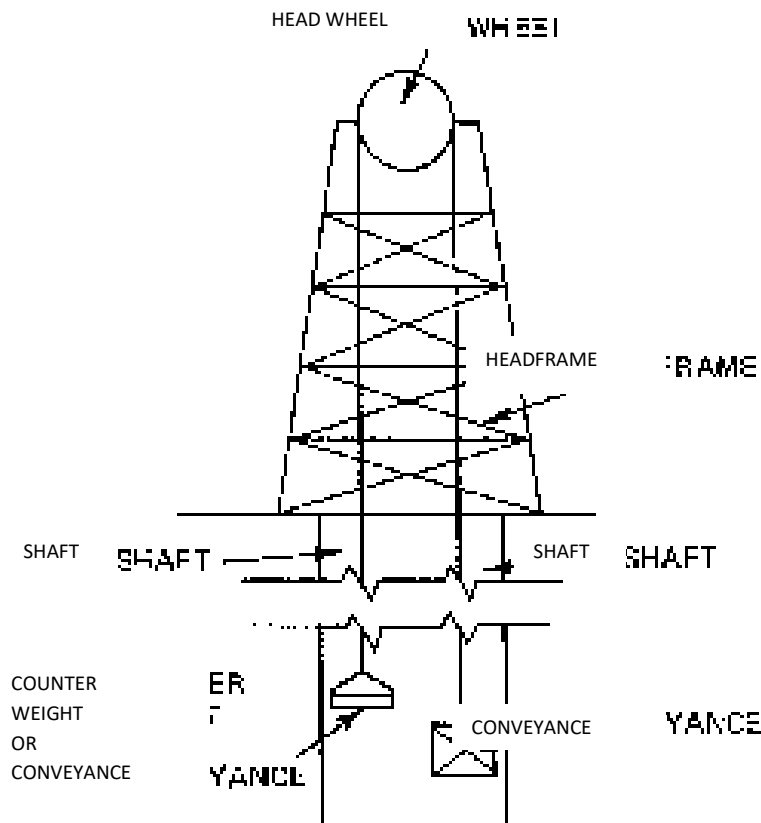

# MINE HOIST OPERATOR TRAINING SYSTEM

## UNIT

### SHEAVES

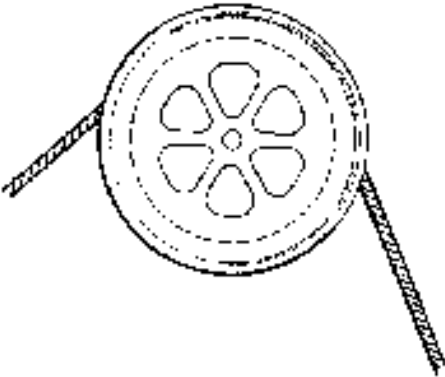

#### OBJECTIVE:

The trainee will know the major components and **STATE** regulations for the sheaves.

#### TIME

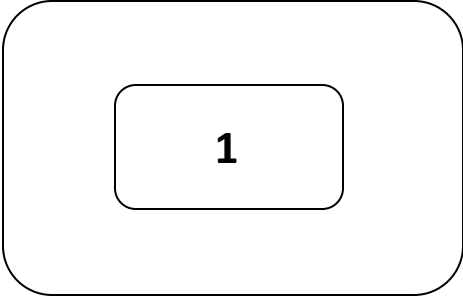

## **INSTRUCTIONAL OBJECTIVES FOR SHEAVES**

The trainee will be able to answer, in writing, fill-in-the-blank questions concerning the function (use) of sheaves.

The trainee will be able to answer, in writing, multiple-choice questions about the function (use) of the head, idler, and knuckle or curve sheaves.

The trainee will be able to identify, in writing, the parts of the sheave.

1. Given an illustration of a sheave where each of the parts is labeled with a letter, the trainee will be able to write the name of each labeled part.
2. The trainee will be able to answer multiple-choice questions about the functions of the sheave parts.

The trainee will be able to answer, in writing, multiple-choice questions concerning the application of State Regulations.

## SHEAVES

A sheave is a grooved wheel which supports the hoist rope. There are three kinds of sheaves:

1. An idler sheave which supports a long length of the rope. (See Figure 1)
2. A knuckle or curve sheave which supports the rope where it changes direction. (See Figure 2)
3. A head sheave which supports the rope and the conveyance at the head of the shaft. (See Figure 3)

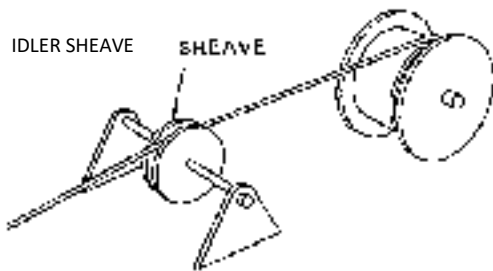

Figure 1 **Figure 1**

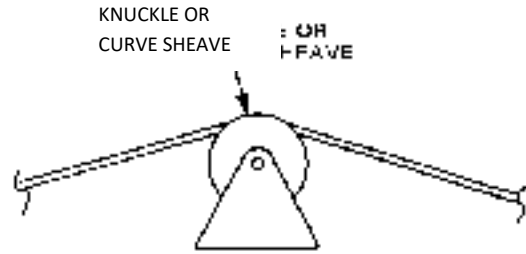

Figure 2 **Figure 2**

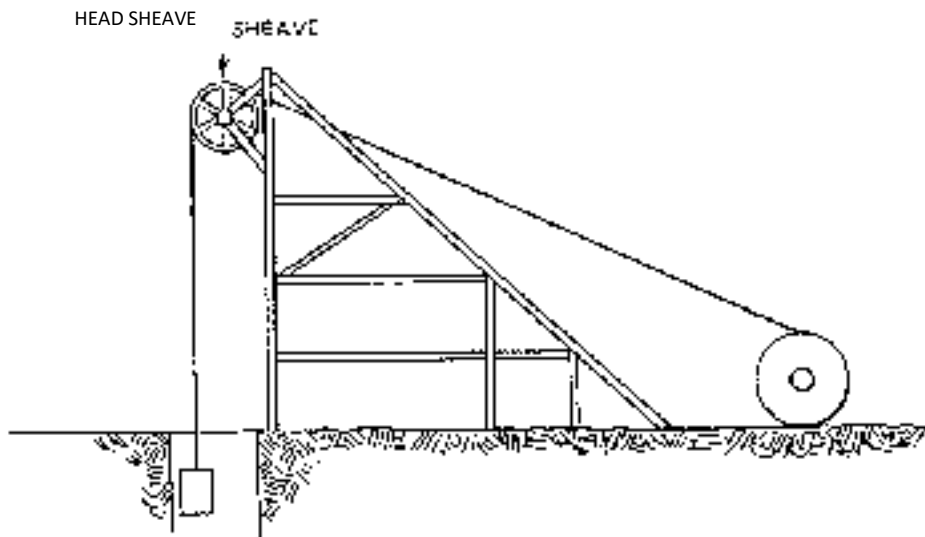

Figure 3 **Figure 3**

The critical features of a sheave are: (See Figure 4)

- Groove
- Diameter

The groove is the part of the sheave that the hoist rope rests on. The size of the groove must be fitted to the size of the rope. (See Figure 5)

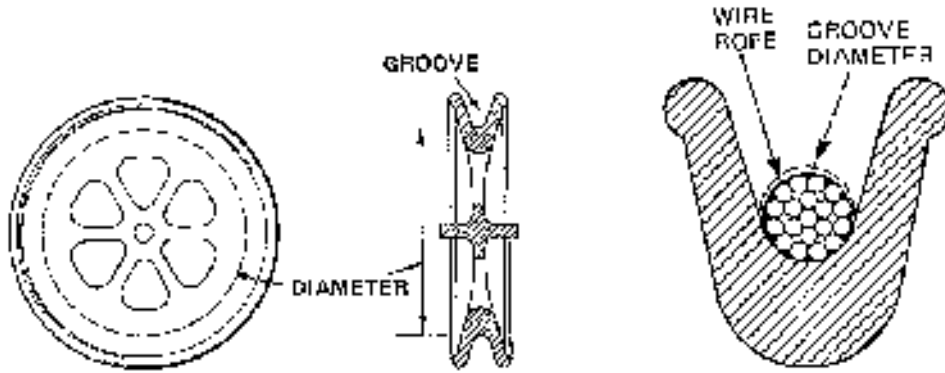

Figure 4

Figure 5

Too large a groove will tend to flatten the rope and cause the rope to weaken. (See Figure 6)

Too small a groove will squeeze, distort and damage the rope as well as damage the groove. (See Figure 7)

In order to save high replacement cost of a worn sheave, liners of wear-resistant metal is used. (See Figure 8)

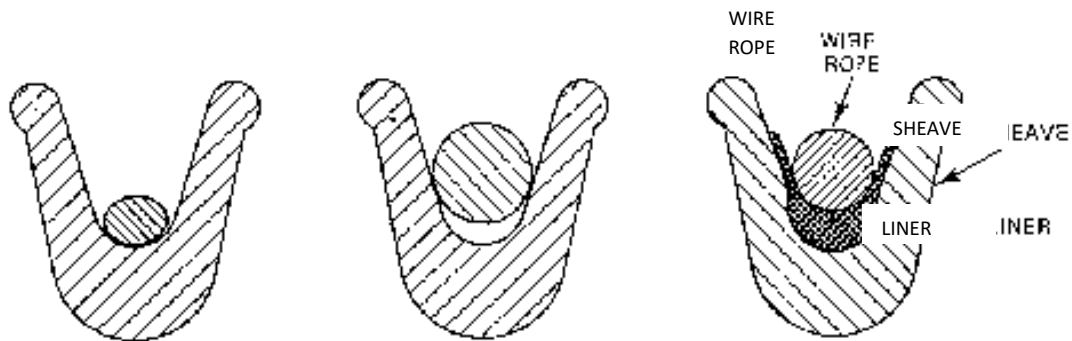

Figure 6

Figure 7

Figure 8

The size of a sheave is described by its diameter. (See Figure 4)

The diameter of the sheave must be suited to the diameter of the rope. Too small a sheave diameter will cause too sharp a bend in the rope and will damage the rope. (See Figure 9)

For the average mine hoist rope, the manufacturers recommend that the sheave diameter be 45 or more times the rope diameter. Little or no wear occurs if the sheave diameter is 90 times the rope diameter. (See Figure 10)

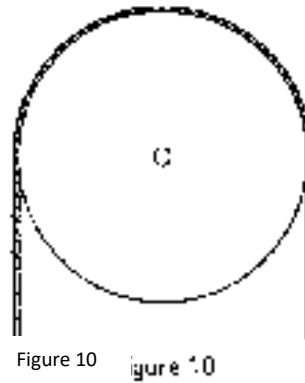
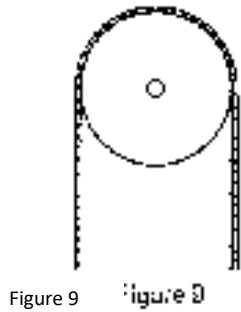

## **REGULATIONS:**

### **Metal and Nonmetallic Mines:**

Head, idler, knuckler and curve sheaves shall have grooves that support the ropes properly. Before installing new ropes, the grooves should be inspected and where necessary machined to the proper contour and the proper groove diameter.

Sheaves shall be inspected daily and kept properly lubricated.

### **Coal Mines:**

#### DAILY EXAMINATION OF HOISTING EQUIPMENT

The daily examination of hoisting equipment shall include:

- An examination of the head sheaves to check for broken flanges, defective bearings, rope alignment, and proper lubrication.



# MINE HOIST OPERATOR TRAINING SYSTEM

## UNIT

### BRAKE SYSTEM

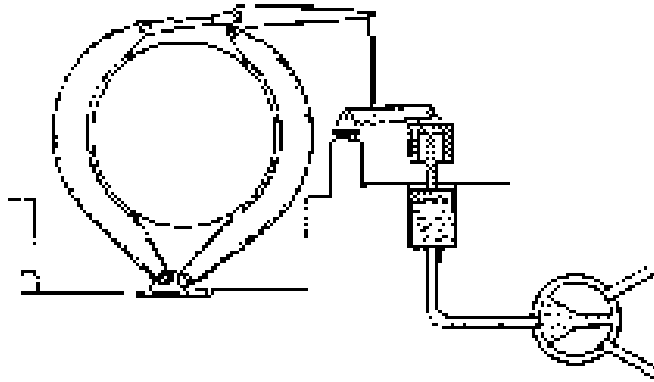

#### OBJECTIVE:

The trainee will know the operating principles, major components and STATE regulations for the brakes.

#### TIME

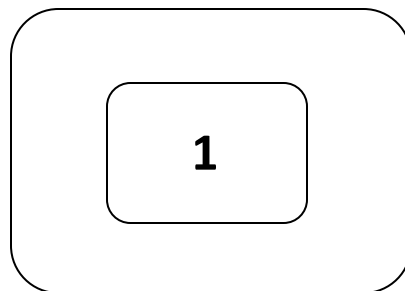

## **INSTRUCTIONAL OBJECTIVES FOR BRAKE SYSTEM**

The trainee will be able to answer, in writing, "fill-in-the-blank" questions concerning the function (use) of the brake system

The trainee will be able to identify in wiring each type of brake.

Given illustrations of disc, jaw or parallel motion brakes, the trainee will be able to label each.

The trainee will be able to describe the operating principles of the hoist brake.

The trainee will be able to answer, in writing, multiple-choice questions about the brake operating principles.

The trainee will be able to answer, in writing, multiple-choice questions concerning the application of State regulations for the hoist brake.

**Brakes** stop the hoist drum and hold it in one position. There are two types of brakes: disc, and ring or drum brakes.

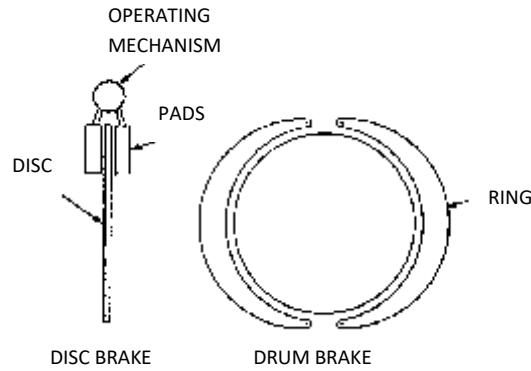

The Disc Brake is connected to the hoist drum like this:

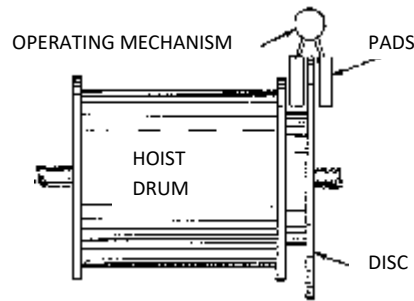

The Ring Brake is connected to the hoist drum like this:

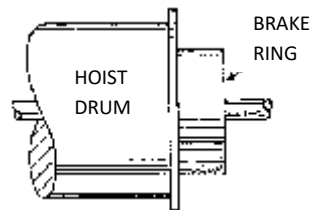

The main parts of a Disc Brake are:

- Disc
- Pads
- Operating mechanism

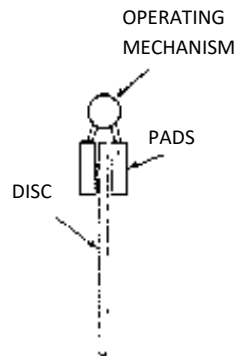

When the brake is applied, the pads come together to press against the disc. This pressure prevents the disc from moving.

There are two types of Ring Brakes:

1. Jaw
2. Parallel Motion

The main parts of a Jaw Brake are:

- Ring
- Shoes or Bands
- Draw Bar
- Operating Mechanism

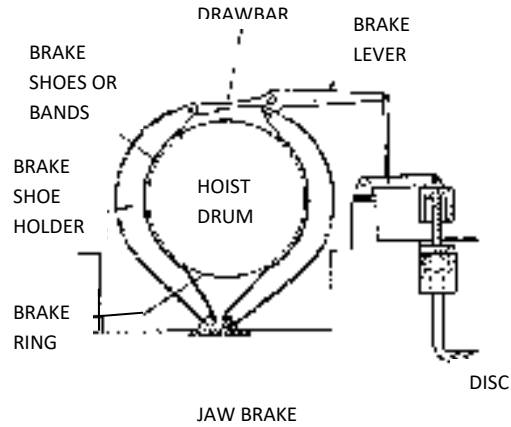

The brakes are operated by a combination of hydraulic and/or pneumatic pressure and gravity or by hand through a system of levers. To apply the brakes, the hydraulic pressure on the cylinder is released. The weight can then pull down on the brake lever, which by pulling on the draw bar brings the brake shoe holders together. This action causes the brake shoes to press against the ring.

To release the brake, hydraulic pressure is restored to the cylinder. The weight is lifted, and moves the brake lever upward. This action allows the brake shoe holders to separate and lift the brake shoes from the brake ring.

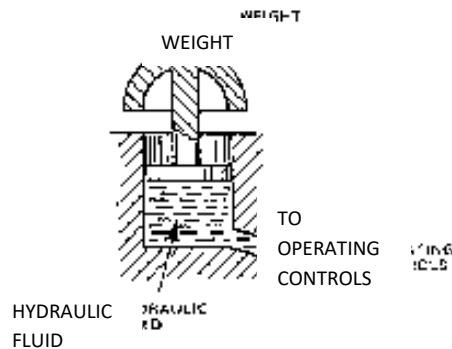

A Parallel Motion Brake is similar to a jaw brake.

The main parts of a parallel motion brake are:

- Ring
- Shoes
- Draw bars (2)
- Operating mechanism

DRAWBAR

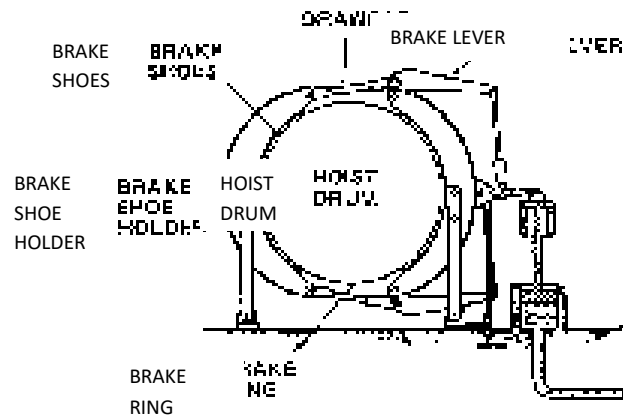

These brakes are also operated by gravity. The weight pulls on both brake levers, and through the draw bars and the brake shoe holders, presses the shoes against the ring.

**STATE REGULATIONS:**

**Metal and Nonmetallic Mines:**

Any hoist used to hoist men shall be equipped with a brake or brakes which shall be capable of holding its fully loaded cage, skip, or bucket at any point in the shaft.

The operating mechanism of the clutch of every man-hoist drum shall be provided with a locking mechanism, or interlocked electrically or mechanically with the brake to prevent accidental withdrawal of the clutch.

Automatic hoists shall be provided with devices that automatically apply the brakes in the event of power failure.

**Coal Mines:**

HOISTS; BRAKES, CAPABILITY.

Brakes on hoists used to transport persons shall be capable of stopping and holding the fully loaded platform, cage, or other device at any point in the shaft, slope or incline.

# MINE HOIST OPERATOR TRAINING SYSTEM

## UNIT

## CLUTCH



### OBJECTIVE:

The trainee will know the operating principles, the major components and the STATE regulations for the clutch.

### TIME

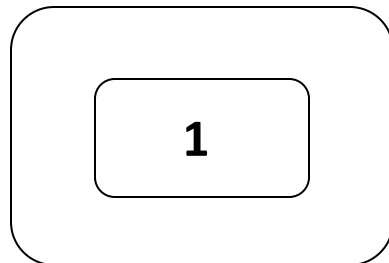

## INSTRUCTIONAL OBJECTIVES FOR THE CLUTCH

The trainee will be able to answer, in writing, multiple-choice questions concerning the function (use) of the clutch.

The trainee will be able to identify each type of clutch.

Given illustrations of a tooth or positive engagement clutch, and a friction or band clutch, the trainee will be able to label each type in writing.

The trainee will be able to identify parts of each type of clutch.

Given an illustration of a tooth or positive engagement clutch, and a friction or band clutch, where each part is labeled with a letter, the trainee will be able to write the name of each labeled part.

The trainee will be able to describe the operating principles for the clutch.

Given an illustration of each type of clutch, the hoist operator will be able to answer, in writing, multiple-choice questions about how each type works.

The trainee will be able to answer, in writing, multiple-choice questions concerning the application of State regulations for the hoist clutch.

## CLUTCH

The clutch is the device which engages or disengages the drum from the hoist motor. There are two basic types of clutch:

1. Tooth or Positive Engagement clutch
2. Friction clutch

The parts of the tooth or positive engagement clutch are: (See Figure 1)

- Clutch spider
- Clutch ring
- Operating mechanism

The Clutch Spider is keyed to the hoist drum shaft.

The Clutch Ring is fastened to the hoist drum frame.

The arms of the spider have grooves or teeth that match those on the clutch ring.

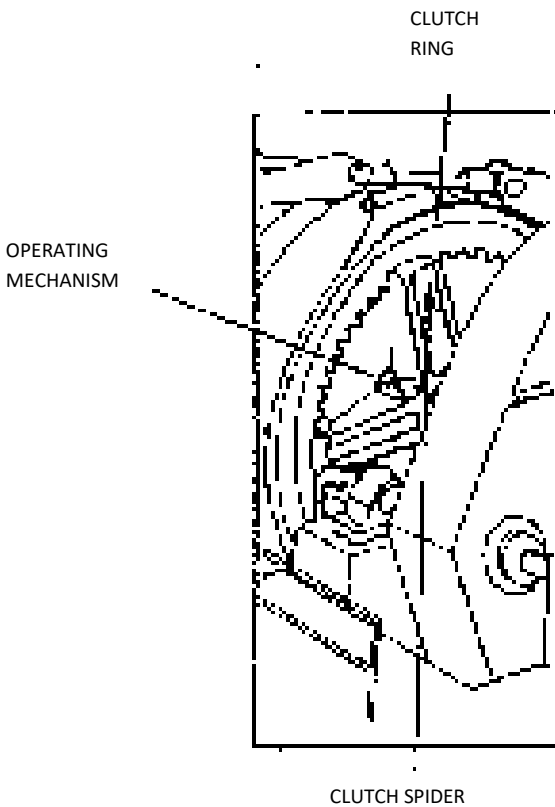

Figure 1



The Operating Mechanism moves the clutch spider away from or toward the clutch ring. This operating mechanism may be hydraulically or pneumatically powered.

When the clutch spider is against the clutch ring, the teeth on the spider engage with the teeth of the ring. If the drum shaft rotates, the clutch spider rotates and causes the drum to rotate.

When the clutch spider is moved away from the clutch ring, the teeth disengage and the clutch is disengaged. The shaft can then turn independently of the drum.

Some hoists have a friction or band clutch. (See Figure 2)

The parts of a Friction Clutch are:

- Clutch ring
- Clutch spider
- Bands
- Friction blocks
- Operating mechanism

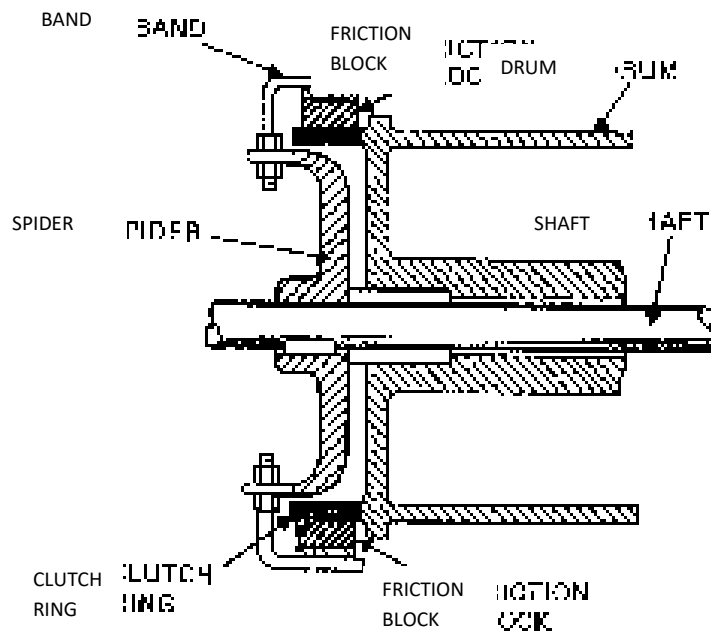

Figure 1

The Clutch ring is fastened to the hoist drum frame.

The Clutch spider is keyed to the hoist drum shaft.

The spider has a band on the end of each arm which supports a friction block.

To engage the clutch, the operating mechanism causes the friction blocks to press against the clutch ring.

Friction between the friction blocks and the ring causes the ring and the attached drum to rotate with the shaft.

To disengage the clutch, the friction blocks are pulled away from the clutch ring.

The hoist is equipped with a clutch brake interlock. This device requires that the brakes be applied to a drum before the clutch can be disengaged.

## **STATE REGULATIONS:**

### **Metal and Nonmetallic mines:**

The operating mechanism of the clutch of every man hoist drum shall be provided with a locking mechanism, or interlocked electrically or mechanically with the brake to prevent accidental withdrawal of the clutch.

### **Coal Mines:**

The clutch of free-drums on man-hoist shall be provided with a locking mechanism or interlocked with the brake to prevent the accidental withdrawal of the clutch.

# MINE HOIST OPERATOR TRAINING SYSTEM

## UNIT

### DRUM/WHEEL

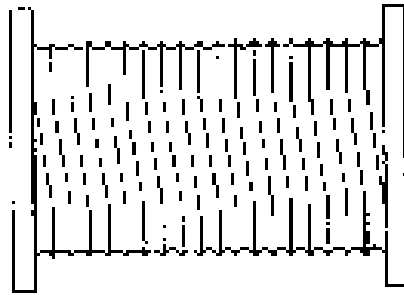

#### OBJECTIVE:

The trainee will know the major components and the STATE regulations from the drum/wheel.

#### TIME

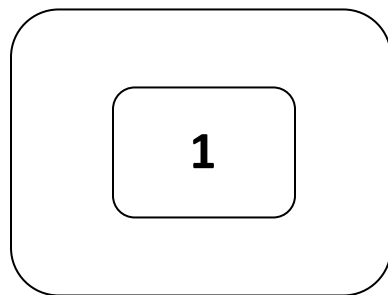

## **INSTRUCTIONAL OBJECTIVES FOR HOIST DRUM OR WHEEL ASSEMBLY**

The trainee will be able to write, in one or two sentences, the function (use) of the hoist assembly.

The trainee will be able to identify the parts of a drum and a Koepe wheel.

1. Given an illustration of a Koepe wheel or a drum hoist assembly where each part is labeled with a letter, the trainee will be able to write the name of each labeled part.
2. The trainee will be able to answer, in writing, multiple-choice questions about the parts.

The trainee will be able to identify the different types of hoist assemblies.

Given illustrations of:

1. Single drum hoist with one or two conveyances
2. Single drum hoist with a conveyance and a counterweight
3. Double drum hoist
4. Koepe wheel or friction hoist

The trainee will be able to label, in writing, each type of illustration.

The trainee will be able to answer, in writing, multiple-choice questions concerning the application of State regulations.

## HOIST DRUM OR WHEEL ASSEMBLY

The hoist assembly lowers and raises the hoist rope into and out of the mine.

There are two basic types of mine hoist assemblies:

1. The Drum hoist in which the hoist rope is wound around a cylindrical drum and stored during the hoisting cycle.
2. The Friction or Koepe wheel hoist in which the rope passes over the wheel during the hoisting process. Friction between the rope and wheel moves the rope.

The drum and wheel are driven by a hoist motor through a gear train and drive shaft. Brakes are provided to slow, stop, and hold the drum or wheel in a particular position.

The parts of a drum are: (See Figure 1)

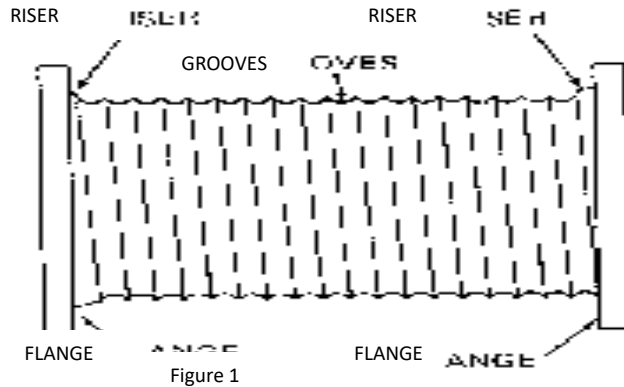

Flanges are the rims around the ends of the drum which prevent the rope from slipping off. Flanges must extend at least two rope diameters (minimum 4") beyond the last wrap.

Risers are metal strips that raise each successive rope layer as it winds at the ends of the drum.

A drum surface may be smooth or it may be grooved. Grooves are channels in the surface of the drum in which the rope lies. Grooves reduce wear on the hoist rope.

There are three types of grooves: (See figure 2)

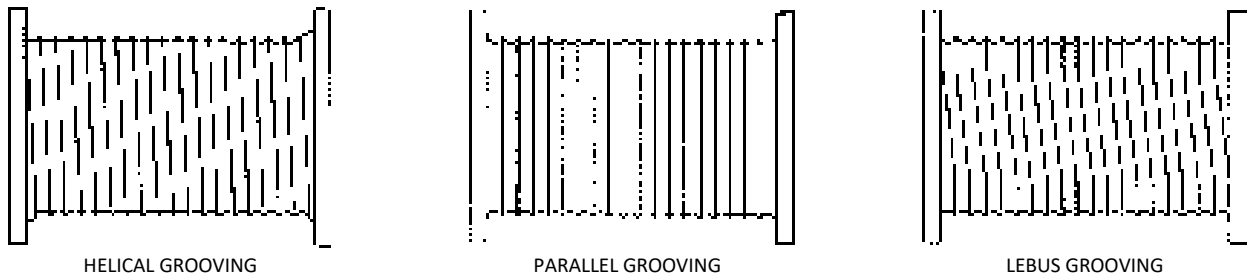

Helical Grooving is a continuous spiral usually used for single layers of rope.

Parallel Grooving is made up of evenly spaced grooves across the entire surface of the drum.

LeBus Grooving is a combination of helical and parallel. One half turn is parallel and then the grooves become helical. This is used for high-speed multi-level winding.

In a Friction or Koepe wheel hoist, the drum is replaced by a wheel. The wheel may be mounted on the head frame, where the head sheave is mounted on a drum hoist. Other hoists may have the Koepe wheel located in the hoist house in place of the regular drum.

The parts of a Koepe Wheel are: (See Figure 3)

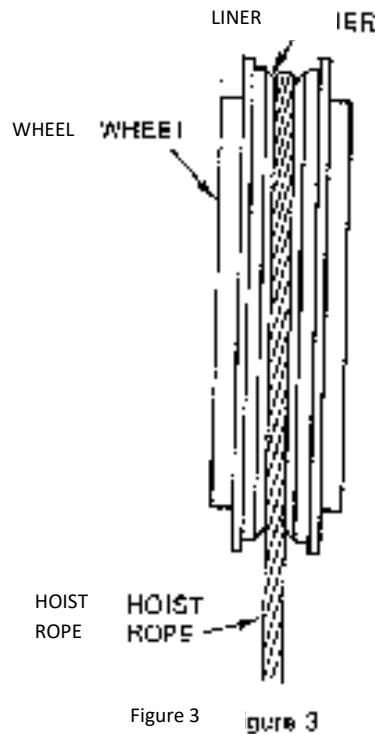

The liner provides a groove for the hoist rope to rest on.

The hoist assembly may take one of several forms.

**Drum Hoist:** Some drum hoists may have only one conveyance and no counterweight. There will be one drum and one rope. One end of the rope is attached to the conveyance and the other is attached to the drum. (See Figure 4)

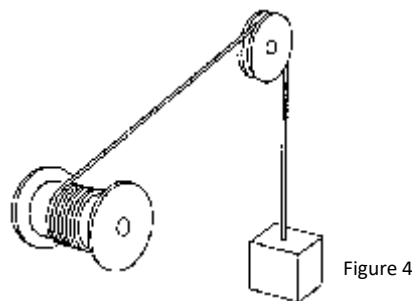

Other single drum hoists may have two conveyances or one conveyance and a counterweight. The ends of the rope are attached to the conveyances or to the conveyance and counterweight. The rope makes several turns around the drum. As one end of the rope is wound onto the drum, its conveyance is hoisted while the other end of the rope is unwound from the drum, and its conveyance or counterweight is lowered. (See Figure 5)

Some hoists have two drums on the same shaft; one rope is on each drum. One end of a rope is fastened to the drum and the other is fastened to the conveyance. The ropes are arranged so that when the rope on one drum is being wound, the rope on the other drum is being unwound. On most two drum hoists, a clutch is provided so that the drums can be operated separately. This clutch is particularly advantageous in a production hoist in a multi-level mine.

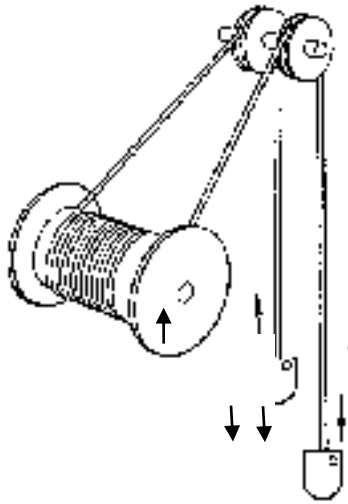
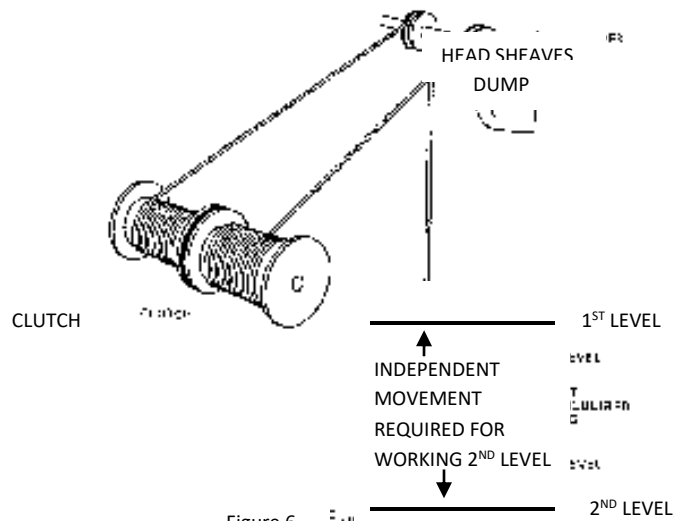

Figure 5

For example, when hauling ore from one level, one skip is at the dump unloading while the other skip is at the loading level being loaded. When the dumping and loading are completed, the loaded skip is raised to the dump while the empty skip is lowered to the loading level, and the unloading and loading operations are repeated. If the loading level is changed, one skip has to be moved in order for a skip to be at the dump while another is at the new loading level. (See Figure 6)



The Koepe Wheel or Friction hoist assembly is similar to the two conveyance one drum hoist, except that there is only ONE half turn of the hoist rope around the wheel. Several small ropes are normally used with the head (Koepe) wheel rather than one large rope. It is necessary that the length of each rope be equal so that the strain on each rope will be equal. (See Figure 7) Tail ropes are provided on friction hoists to compensate for the weight of the hoist ropes.

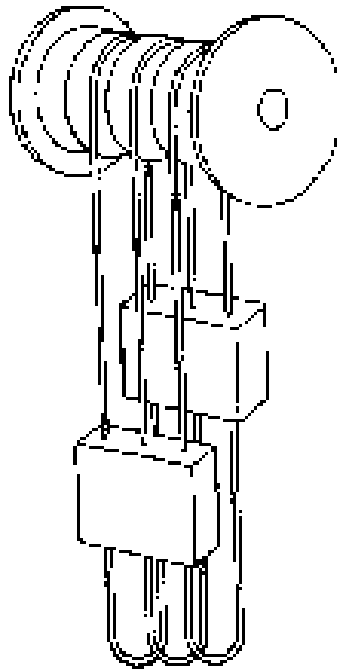

Figure 7

**STATE REGULATIONS:**

**Metal and Nonmetallic Mines:**

Flanges on drums shall extend radially, a minimum of **3** rope diameters, and not less than 4 inches beyond the last wrap.

Where grooved drums are used, the grooves shall be of suitable size and pitch for the rope used.



# MINE HOIST OPERATOR TRAINING SYSTEM

## UNIT

# WIRE ROPE

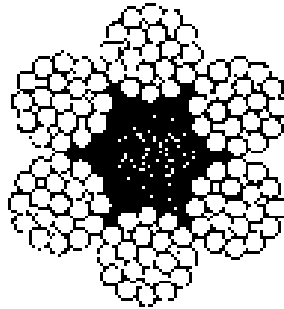

### OBJECTIVE:

The trainee will know the major components, usage, maintenance and inspection procedures and STATE regulations for the wire rope.

### TIME

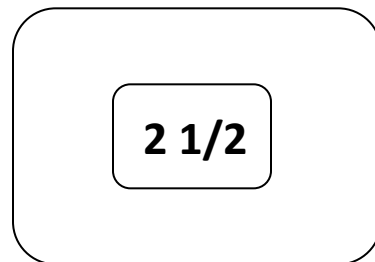

## **INSTRUCTIONAL OBJECTIVES FOR WIRE ROPE**

The trainee will be able to answer, in writing, multiple-choice questions concerning the functions (uses) of wire rope.

The trainee will be able to describe the parts of a wire rope:

1. Given an illustration of the wire rope where each part is labeled with a letter, the trainee will be able to write the name of each labeled part.
2. The trainee will be able to answer, in writing, multiple-choice or matching questions about these parts.

The trainee will be able to identify different lays of rope.

Given illustrations of lays of rope, the trainee will be able to label, in writing, each type.

The trainee will be able to describe the procedures for making an eye.

Given illustrations of an eye being formed using U-clips, a socket, a wedge socket or an eye splice, the trainee will be able to arrange these illustrations in the order the steps are performed.

The trainee will be able to calculate the rope safety factor.

Given a problem where the breaking strength and normal load are given, the trainee will be able to write the safety factor.

The trainee will be able to explain the rope designation.

Given a rope designation, the trainee will be able to write the meaning of each number.

## WIRE ROPE

The care, installation, maintenance, and inspection of the hoist rope are engineering and/or maintenance functions. The hoist operator, however, is usually required to assist the responsible group. This unit will prepare the hoist operator to carry out his/her usual responsibilities. In mines where the hoist operator will be called upon to carry a heavier share of this load, he/she should receive further training. Many of the hoist rope manufacturers publish excellent texts which should be used for such training.

### WIRE ROPE USE:

Wire rope is used for the hoist rope and, in some mines, for shaft guides. It may also be used for guy wires for structures.

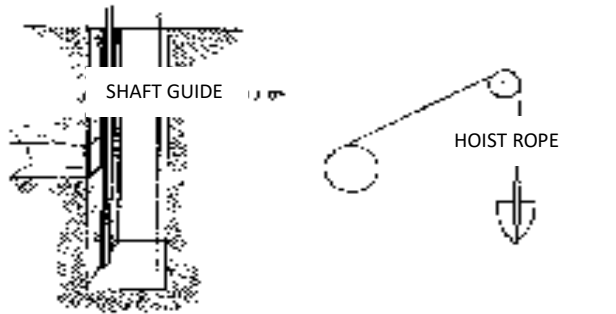

Wire rope that bends frequently while in use, for example the hoist rope, must be flexible. It is made up of many wires of small diameter.

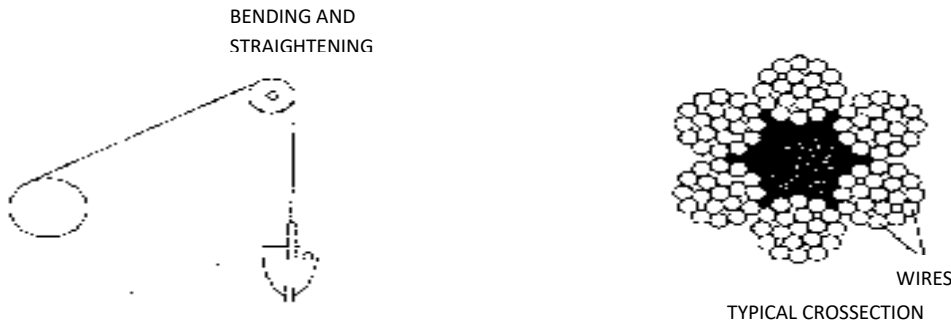

Wire rope that does not bend in use, for example shaft guides, need not be flexible. It is made up of few wires of large diameter.



**WIRE ROPE TERMS:**

There are THREE parts to a wire rope:

1. A Core, which forms the center of the rope.
2. Wires, which are twisted into strands. The wires which bear against a sheave or drum are called crown wires.
3. Strands, which are twisted around the core into rope.

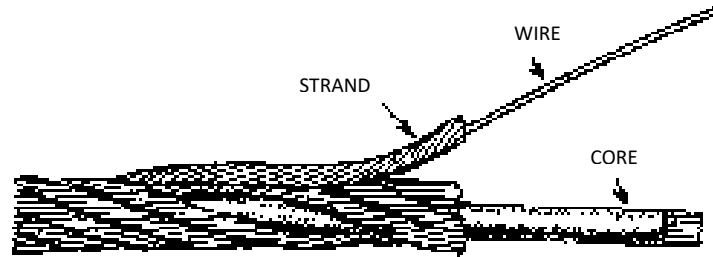
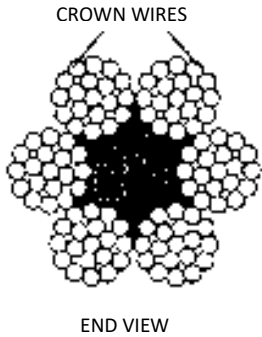

Rope is designated by the NUMBER OF STRANDS multiplied by the NUMBER OF WIRES PER STRAND and ROPE DIAMETER.



This rope has 18 strands of 7 wires each.  
It is an 18 x 7.

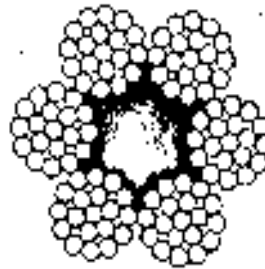

This rope has 6 strands of 19 wires each.  
It is a 6 x 19.

Rope diameter is measured like

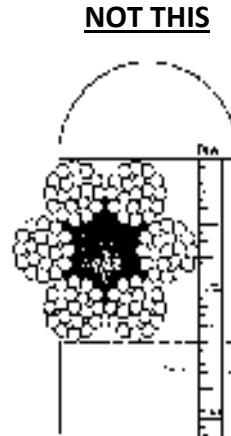
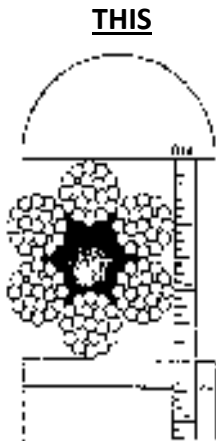

This is a 1 1/2" Rope

**Lay** of rope:

The length of rope that it takes for one strand to make a complete turn-around the core is a Lay.

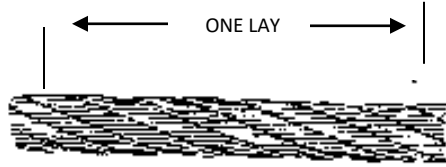

**Right Lay:**

If the strands are twisted to the right, the rope is Right lay.



RIGHT LAY

**Left Lay:**

If the strands are twisted to the left, the rope is Left Lay.



LEFT LAY

**Regular Lay:**

If the strands are twisted in one direction and wires are twisted opposite direction, the rope is Regular Lay.



REGULAR LAY

**Lang Lay:**

If the strands and wires are twisted in the same direction, the rope is Lang Lay.



LANG LAY

## Safety Factor

The breaking strength of the rope divided by the load on the rope is the Safety Factor.

$$\text{Safety Factor} = \frac{\text{Breaking Strength}}{\text{Load}}$$

A rope with a 100,000-pound breaking strength carrying a normal load of 10,000 pounds has a Safety Factor of  $\frac{100,000}{10,000}$  or 10.

The safe working load is 1/5 of the breaking strength.

## **WIRE ROPE CARE**

Wire rope is expensive. Handle it carefully to prolong its life.

### Avoid Sharp Bends

The use of too small of a sheave or drum, or kinking will cause the wire rope to be weakened.

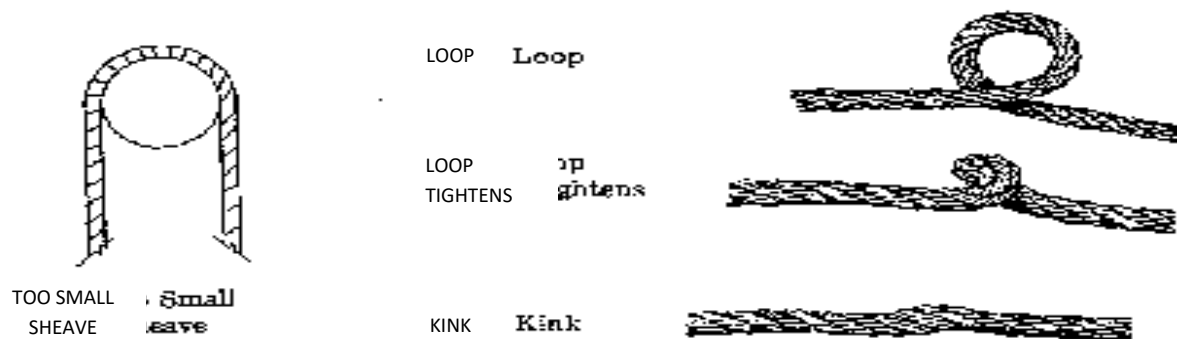

### Avoid Reverse Bending

When transferring rope from Reel to Drum,

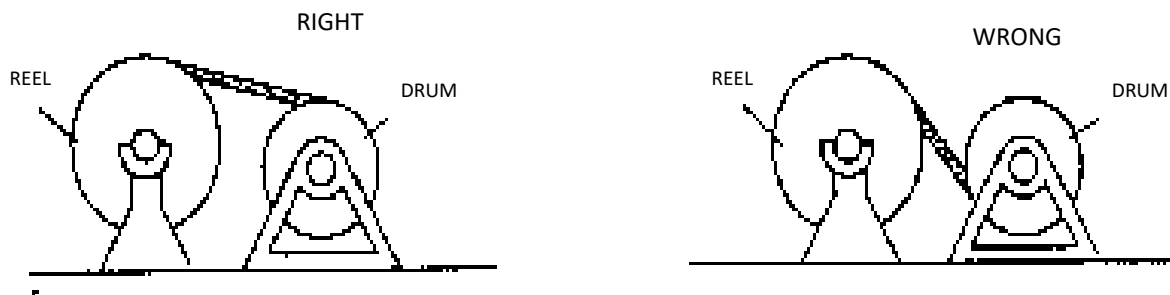

or in the rope run, reverse bending should be avoided.



## Use Proper Rope Lay

On **OVERWOUND** drums, start Right Lay from Left -- Left Lay from Right.

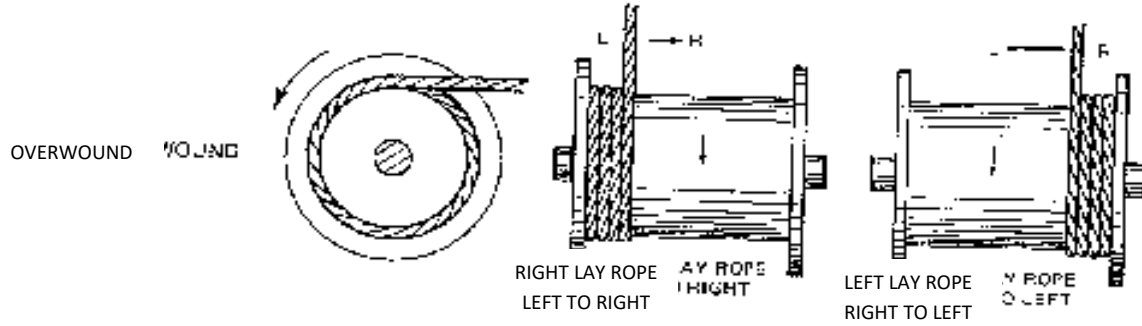

On **UNDERWOUND** drums start Right Lay from Right - Left Lay from Left.

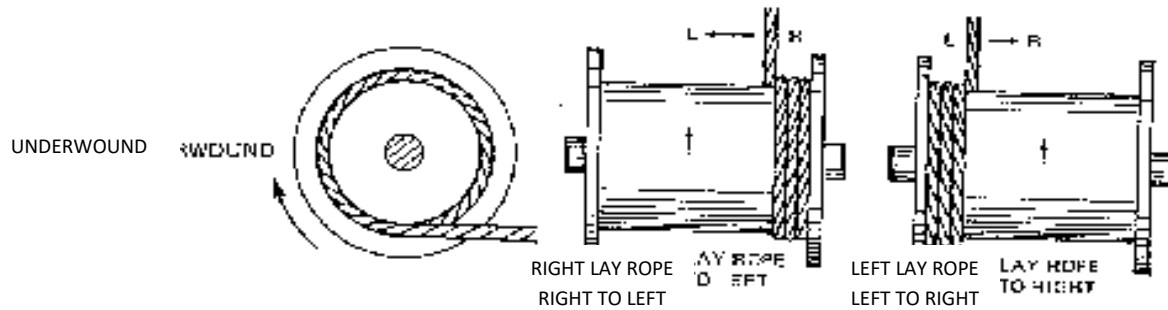

In all cases Use the Right Rope for the Job.

## **Cutting and Attaching Wire Rope**

Wire rope is weakened if its shape or structure is changed. In cutting and attaching wire rope, the shape and structure is usually preserved by "seizing," that is, wrapping the rope with small wire.

### Cutting

At least three seizings are made on each side of the planned cut.

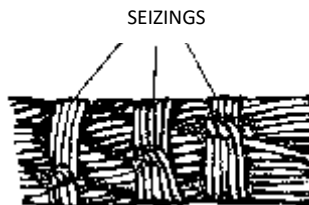

## Attaching the Wire Rope

Normally an eye is put into the end of a wire rope to attach it to a drum, conveyance, counterweight or other object. A thimble is usually placed in the eye for support.

The long end of the rope is the live or working end.

The short end is the dead or bitter end.

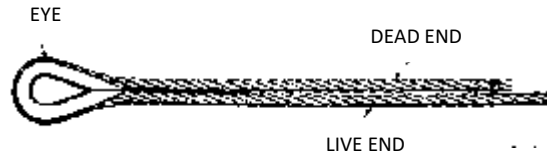

The eye can be put into the end of the rope with:

- U-clips

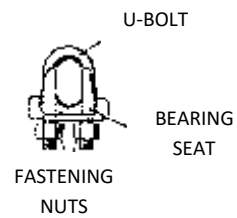
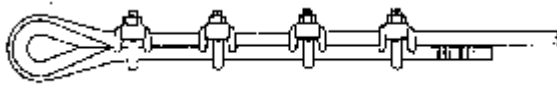

- A Socket



- An Eye Splice

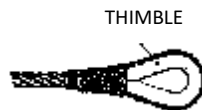

- A Wedge Socket

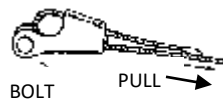

U-clips are often used because the process is simple and readily done by the average mechanic.



## U-Clips:

With U-Clips the eye is formed in 5 steps:

STEP 1- Calculate the number of clips and the slip spacing:

The number of Clips (N) = 3 x Rope Diameter + 1

For a 1" Rope:  $N = 3 \times 1 + 1 = 4$  clips required

Clip spacing = 6 x Rope Diameter  
= 6 x 1 = 6 inches.

STEP 2- Form the Eye around the Thimble.

The length of the dead end is usually equal to

Number of Clips x Clip Spacing = 4 x 6 = 24"

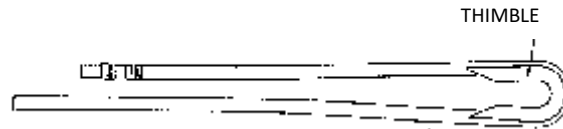

STEP 3- Attach the U-Clip farthest from the Eye. Note that the U-bolt touches the bitter end, **NOT** the working end.

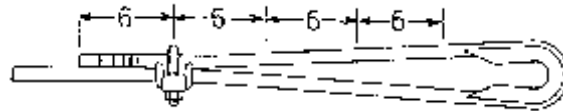

STEP 4- Attach the U-Clip nearest the Eye.

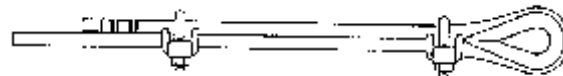

STEP 5- Attach and tighten the remaining clips.

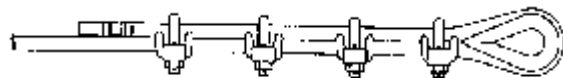

**Socket:**

The eye is formed with a Socket in 5 steps:

STEP 1- Arrange the wire in the form of a brush down to the first seizing. If the rope has a non-metal core, remove the core down to the first seizing.



STEP 2- Clean the "brush" with solvent (kerosene or similar); dry off solvent; dip in ¼ of brush into muriatic acid, then clean brush with a soda mixture.

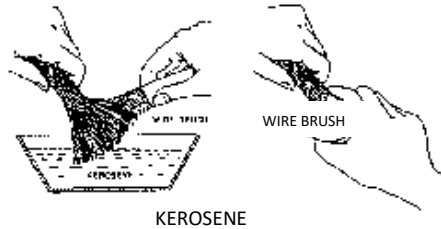

STEP 3- Heat socket to 200° F, insert brush in socket; keep brush centered and perpendicular in the socket.

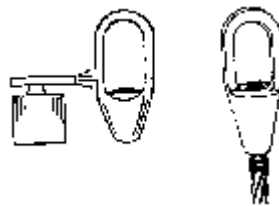

STEP 4- Put the fire clay or putty around the base of the socket and pour high grade Zinc (ASTM-SPEC. 8-6-58) heated from the 850° F to 1000° F into the socket.

Having the Zinc at the RIGHT TEMPERATURE is very important.



STEP 5- Remove the fire clay and lubricate the rope up to the socket.

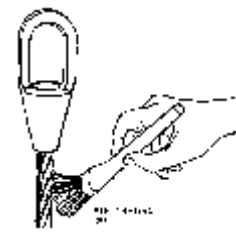

PENETRATING OIL

**Eye Splice:**

The EYE is formed with a Splice in 4 steps:

STEP 1- Form the eye around the thimble about 1 lay from the dead end and separate the strands that extend beyond the thimble on the dead end.

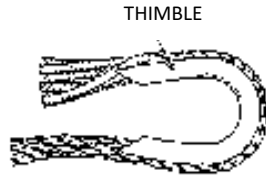

STEP 2- Use a steel spike (MARLINSPIKE) to separate the strands on the working end.



STEP 3- Interlace the strands from the dead end into the separations in the working end until each strand from the dead end has been laced over and under at least 3 times.



STEP 4- Cover the spliced area with seizing wire.

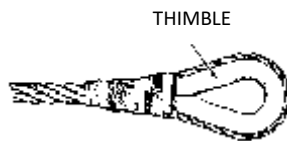

**Wedge Socket:**

The EYE is formed with a Wedge Socket in 4 Steps:

STEP 1- Form a loop through the socket.

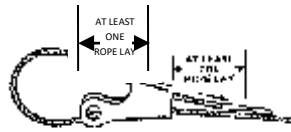

STEP 2- Insert the wedge.

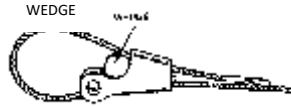

STEP 3- Pull wedge and rope into position.

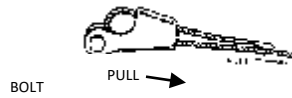

STEP 4- Final tightening occurs under full load.

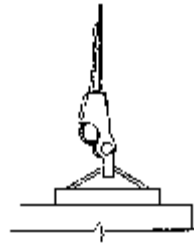

## WIRE ROPE INSPECTION

Federal Regulations require that wire ropes used for hoisting shall be inspected regularly.

Parts of the wire rope that require close inspection are:

1. Points where the rope is connected to the conveyance and drum;
- 2, 3, & 4. Points where the rope leaves the sheaves or drums when the conveyance is at the loading levels or dump levels.
5. Every 100 feet.

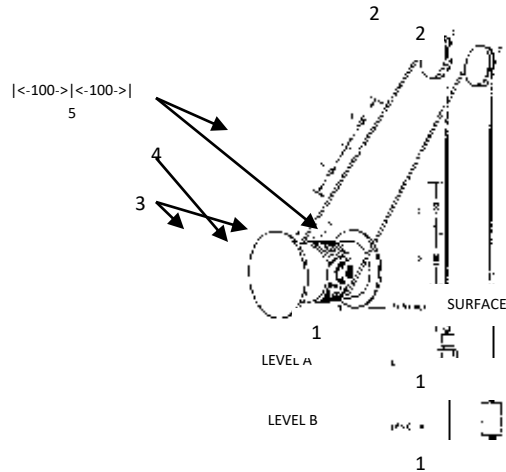

Defects that will require ropes to be removed from the hoist:

- Corrosion or distortion, as from a kink;



- Reduced wire rope diameter

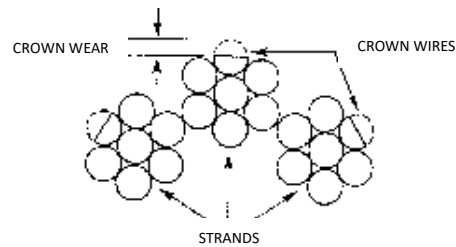

- 65% crown wear;
- More than 6 broken wires in one lay of rope;
- 30% crown wear and 3 broken wires in one lay;
- Dead rope; rope will not stretch under load.

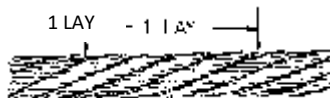

Manufacturer's texts provide charts from which the ropes strength can be readily calculated if the number of broken wires in one LAY and "L", the length of wear on the crown wires, are known.

## Inspection Process

The inspector will:

- Clean off a full lay of the rope surface with solvent
- Measure and record the rope diameter
- Measure and record the length of crown wear
- Note and record the number of broken wires in that lay
- Move the conveyance until the next inspection point on the rope is at the inspection station.

## **LUBRICATION**

Several methods of lubricating the wire rope are:

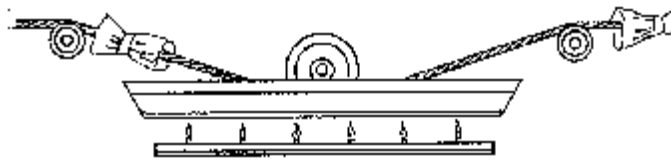

HEATED

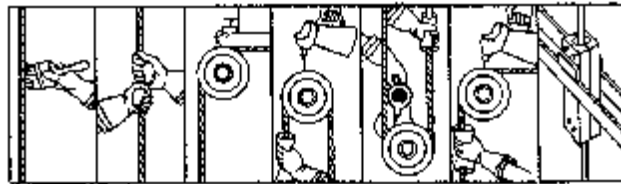

PAINT IT

SWAB IT

DRIP IT

POUR IT

BATHE IT

UNHEATED

## CHANGE THE HOIST ROPE

Specific procedures for changing the hoist rope vary depending upon the type of hoist, the space available in the immediate vicinity of the hoist and the collar, and the rewinding equipment available.

The basic procedure on a two-conveyance double-drum with no clutch hoist is as follows:

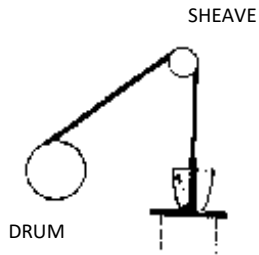

- Raise one conveyance to the highest level and block it.

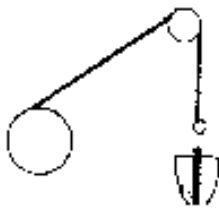

- Remove the old rope from the conveyance.

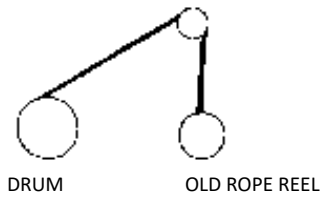

- Attach the old rope to an empty reel and transfer the old rope from the drum to the empty reel.



- When the old rope is unwound from the first drum, detach it from the drum and attach a small rope to the old rope.

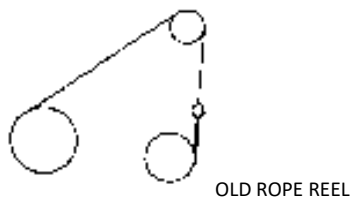

- Continue winding until all of the old rope is on the reel. The small rope will extend from the drum, through the head sheave to the reel.

# MINE HOIST OPERATOR TRAINING SYSTEM

## UNIT

# DEPTH INDICATOR



### OBJECTIVE:

The trainee will know the operating principles of the depth indicator.

### TIME

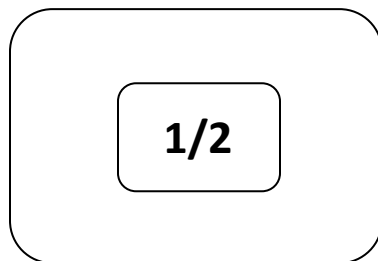



## **INSTRUCTIONAL OBJECTIVES FOR DEPTH INDICATOR**

The trainee will be able to answer, in writing, multiple-choice questions concerning the function (use) of the depth indicator.

The trainee will be able to identify each type of depth indicator.

Given illustrations of a dial depth indicator and a cylindrical depth indicator, the trainee will be able to label, in writing, each type.

The trainee will be able to describe the operating principles of the depth indicator.

The trainee will be able to answer, in writing, multiple-choice questions about how each indicator works.

The trainee will be able to answer, in writing, multiple-choice questions concerning the application of State regulations for the depth indicator.

## DEPTH INDICATOR

The depth indicator shows the vertical position of the conveyance in the shaft.

The depth indicator may be in the form of a dial or a cylinder.

### Dial Depth Indicator:

Figure 1 shows a dial indicator. The arrow is geared to the drum and moves around the dial. The position of the dump or collar and each working level is indicated on the dial. When the arrow points to a position, the conveyance is at that position.

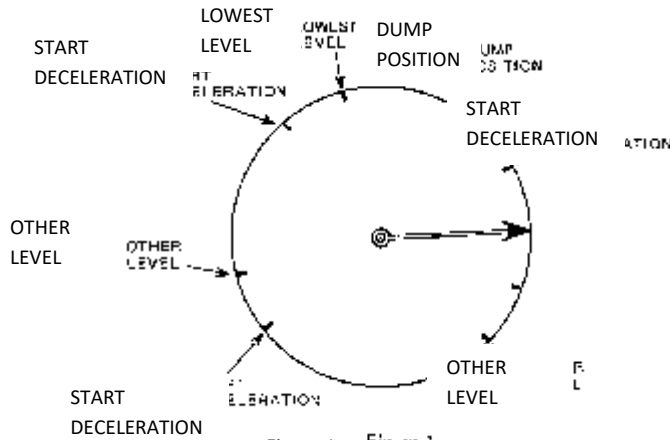

Figure 1

Usually the experienced hoist operator will add other marks at each stopping point to show where he/she must decelerate in order to slow in time to make a smooth stop.

He/she may also make other marks if the stopping point changes because of a heavier load.

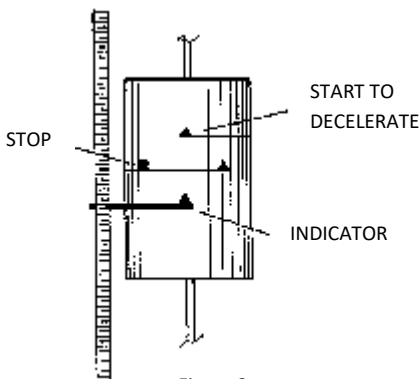

Figure 2

### Cylinder Depth Indicator

The cylindrical depth indicator is shown in Figure 2.

The threaded shaft and the cylinder rotate with the hoist drum.

The indicator moves up and down on the threaded shaft as the conveyance moves up and down the mine shaft.

The hoist operator marks the points on the cylinder that correspond to the dump level, working level(s), collar and other significant points in the mine shaft. He/she may also mark points where the conveyance should decelerate, or reach cruise speed, and other points where operator action is required.

**Marks on Drum:**

Experienced operators may also mark the flange of the drum to provide a more accurate and easily read indication of the position of the conveyance.

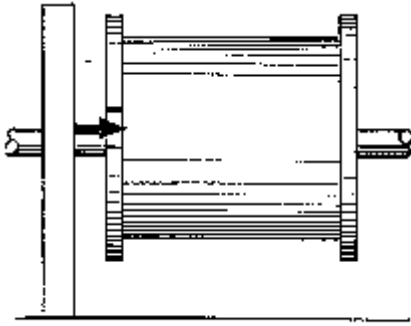

Figure 3

**STATE REGULATIONS:**

Metal and Nonmetallic:

An accurate and reliable indicator of the position of the cage, skip, bucket, or cars in the shaft shall be provided.

Coal Mines:

An accurate and reliable indicator of the position of the cage, platform, skip, bucket, or cars shall be provided.

Hoists; Indicators:

The indicator shall be placed so that it is in clear view of the hoisting engineer and shall be checked daily to determine its accuracy.

# MINE HOIST OPERATOR TRAINING SYSTEM

## UNIT

### SAFETY CONTROLLER

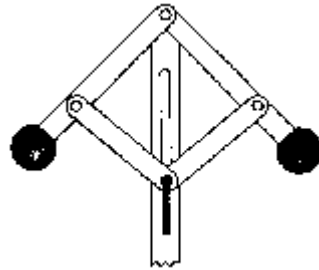

#### OBJECTIVE:

The trainee will know the major components and operating principles for the safety controller.

#### TIME

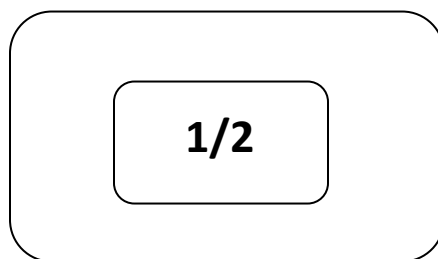

## **INSTRUCTIONAL OBJECTIVES FOR SAFETY CONTROLLER**

The trainee will be able to answer, in writing, multiple-choice questions concerning the function (use) of the safety controller.

The trainee will be able to identify the parts of a safety controller.

Given illustrations of the governor and the depth indicator, the trainee will be able to label each.

The trainee will be able to explain the operating principles of a safety controller.

The trainee will be able to answer multiple choice questions about the operating principles of the safety controller.

## SAFETY CONTROLLER

The Lilly, Simplex or any other automatic controller, is a multi-purpose safety device synchronized with the movement of the drum shaft. The basic controller prevents over-speed and over-travel, and also applies the brake of an electronic hoist in case of power failure.

The controller consists of:

- A Governor, which prevents over-speed. (See Figure 1)

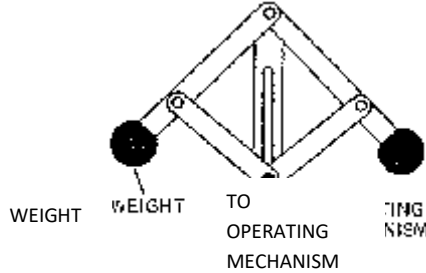

Figure 1

Safe operation of the hoist requires that the conveyance starts moving at a slow speed, accelerates to cruising speed, and then decelerates to a stop at the destination.

If the drum over-speeds, the weights of the governor will move outward due to centrifugal force and through linkages, cut off power to the hoist motor and set the brake.

- A Depth Indicator, with over-travel switches. (See Figure 2) This is in addition to the depth indicator discussed in unit I-A-12-2, "Depth Indicator."

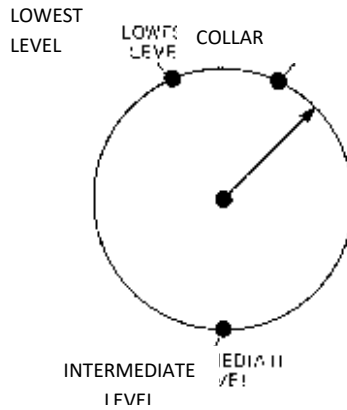

Figure 2

If the conveyance travels too far above the dump position or too far below the lowest working level, power will be cut off from the hoist motor automatically.

The controller is designed to permit only low conveyance speed in the acceleration and deceleration stages, and higher speed only in the cruising stage. Most controllers sound warning bells or buzzers as the conveyance leaves the cruising stage and enters the deceleration stage.

# MINE HOIST OPERATOR TRAINING SYSTEM

## UNIT

### CONTROL PANEL

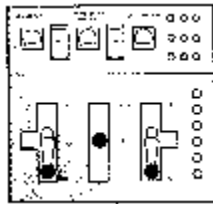

#### OBJECTIVE:

The trainee will know the major components of the hoist control panels.

#### TIME

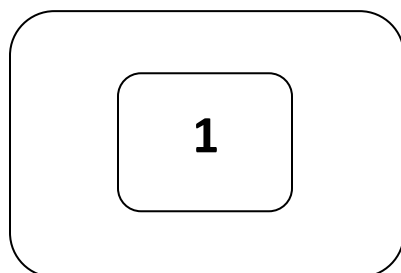

## **INSTRUCTIONAL OBJECTIVE FOR THE HOIST CONTROL PANEL**

The trainee will be able to answer “fill-in-the-blank” questions concerning the function (use) of the hoist controls and indicators.

The trainee will be able to identify the hoist controls and indicators.

1. Given illustrations of hoist controls and indicators, where each part is labeled with a letter, the trainee will be able to write the name of each lettered part.
2. The trainee will be able to answer, in writing, multiple-choice questions concerning the hoist controls and indicators.

The trainee will be able to label, in writing, the types of control panels: single drum hoist, double drum, single clutch hoist, and a double drum, double clutch hoist.

The trainee will be able to answer, in writing, multiple-choice questions concerning the application of state regulations for the hoist panel.



## HOIST CONTROL PANEL

The hoist controls and indicators are grouped together on a control panel within easy reach or sight of the hoist operator's position.

The controls may be set of levers, handles or pushbuttons or switches.

The levers are used for:

- Hoist motor control
- Hydraulic or mechanical brake control
- Clutch control
- Electric brakes



Pushbuttons or switches are used to:

- Control the communication systems
- Override the slack rope, over-travel, deadman, and similar safety switches
- Operate the main power switch
- Place the hoist in manual or automatic operation
- Start and stop accessories such as the hydraulic system, air compressor, or

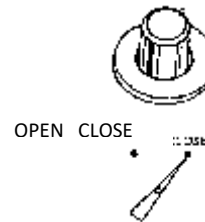

The indicators may be lights, meters and dials.

Light indicators show the condition of the hoist components and of other vital mine machinery.

These lights may indicate:

- Operating method of the hoist— manual or automatic
- Condition of bypass switch
- Clutches engaged or disengaged
- Safety gates opened or closed
- Precise position of the skip in the loading or dump area
- Warning of low lubrication oil pressure, low hydraulic or air pressure, or ventilation or flood control machines not operating
- Various equipment running or stopped.



Meters may indicate:

- Lubrication Oil, air or hydraulic pressure
- Current flow or voltage
- Rope speed



AMMETER

The depth indicator, which shows the position of the conveyance, may be a dial or cylindrical indicator.

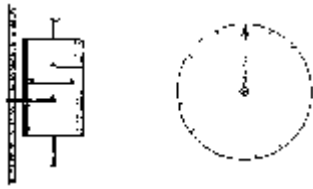

The controls and indicators are grouped around or on the control stand. The levers may be mounted on the stand or on the floor near the stand. Figures 1, 2 and 3 are examples of the arrangement of hoist controls for single drum hoists, double drum hoists with a single clutch, and double drum hoists with two clutches. The controls for the hoist you will operate may have a different arrangement than those shown. The basic controls and indicators, however, will be similar.

### Single Drum Hoist

The control panel in Figure 1 is for a single drum hoist.

The brakes are set when the control handle is pulled back and released when it is pushed forward.

The rope on an over-wound drum will be lowered when the motor control is pushed forward and raised when the motor control is pulled back

Electric braking can be done by reversing the motion of the control that is, pulling the motor control lever back if lowering, and pushing it forward if hoisting.

If the hoist has an AC motor with dynamic braking, an additional switch and lever are provided to control the braking.

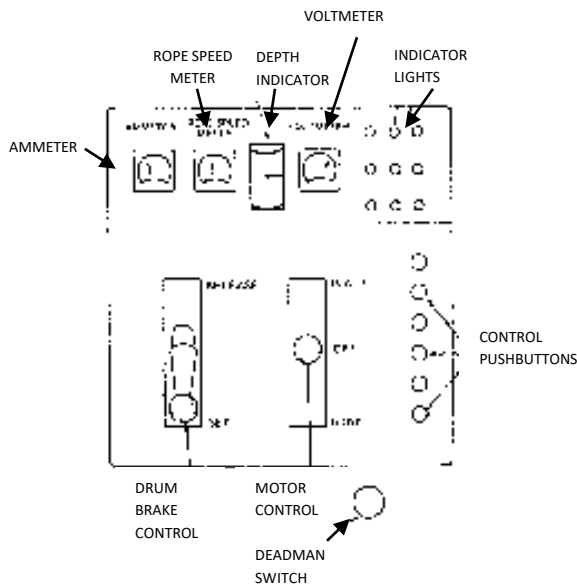

Figure 1

The control panel in Figure 2 is for a double drum hoist with a clutch on the left drum only.

The clutch and left drum brake are controlled by the same lever. The clutch is engaged when the lever is pulled to the right and disengaged when it is pulled to the left. The left drum brake must be applied in order to get the clutch operating lever in the disengaged position.

Some control stands have separate operating levers for the clutch and brake. The levers are interlocked, however, to prevent disengaging the clutch when the drum brake is not applied.

Some double drum hoists do not have a clutch and will have only one brake operating lever.

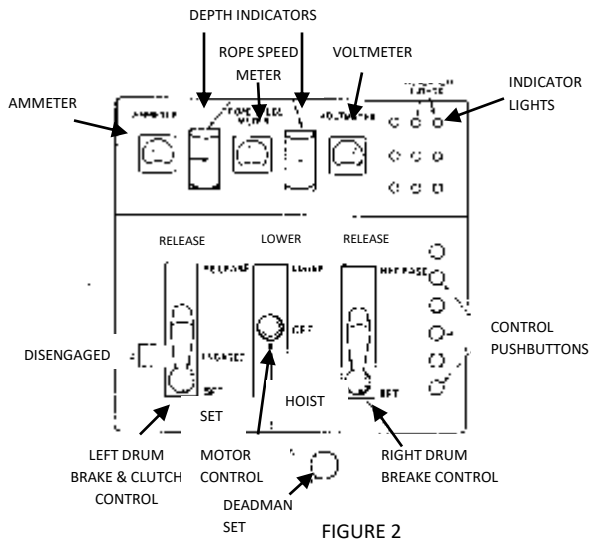

### Double Drum, Double Clutch Hoist

The control panel in Figure 3 is for a double drum, double clutch hoist.

The clutches are interlocked with the brakes just the same as in the double drum, single clutch hoist.

Either drum can be operated as a single drum hoist.

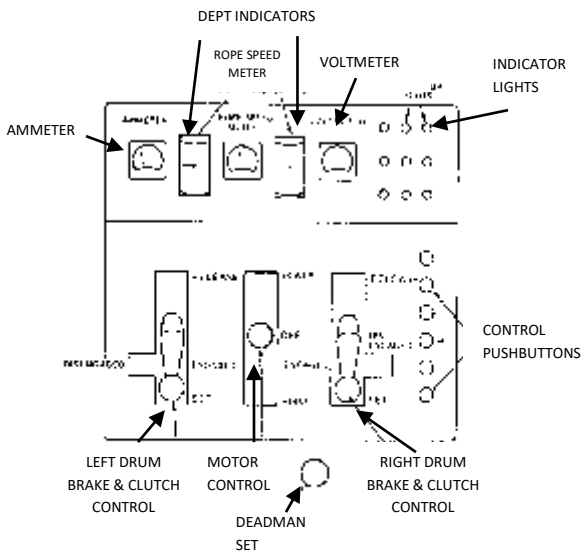

FIGURE 3

# MINE HOIST OPERATOR TRAINING SYSTEM

## UNIT

### COMMUNICATION SYSTEMS



#### OBJECTIVE

The trainee will know the communication systems and the STATE regulations for these systems.

#### TIME

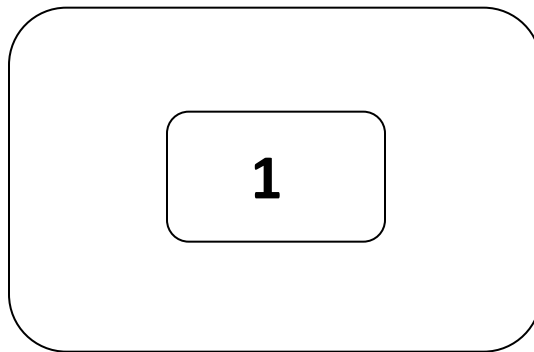

## **INSTRUCTIONAL OBJECTIVES FOR COMMUNICATION SYSTEMS**

The trainee will be able to answer, in writing, multiple-choice questions concerning the function (use) of the communication systems.

The trainee will be able to describe the uses of different communication systems.

Given a list of the communication systems where each system is lettered, and a list of the uses of these communication systems, the trainee will be able to match each system to its use.

The trainee will be able to answer, in writing, multiple-choice questions concerning the application of state regulations for communication systems.

## COMMUNICATION SYSTEMS

Communication systems provide the means of transferring information from one location to another

Types of information to be transferred:

Direct orders or requests—

The skip tender may request that the skip be lowered to his/her working level.

Explanation of orders or requests—

The skip tender may need the conveyance for a special purpose or proceed or follow-up his/her request with an explanation.

Information that indicates the condition of equipment or of the mine environment—

The skip or tender may need to inform the supervisor at the surface of the presence of a breakdown of the loader.

Types of Communication Systems:

- Hoist bell
- Telephone
- High frequency radio
- Public address system
- Indicator lights
- Meters and/or gauges
- Closed-circuit TV

Use of each communication system:

The Hoist Bell is used to request or order the movement of the conveyance. For example, the skip tender, using a series of bells, will signal a request for the conveyance to be brought to his/her level.



The Telephone or Radio is used for longer messages. For example, the hoist operator may tell the skip tender that the conveyance will not be available for a time. Therefore, the answer to the request will be delayed.



The Public Address System is used to pass information to many people over a wide area. For example, it may be used to give a general announcement or to issue a warning in case of an emergency.



Indicator Lights are normally used to communicate that a malfunction has occurred, that power is on or off, or that a machine is operating. For example, in some mines an indicator light in the hoist room will show that the pumps are running.



Meters and Gauges communicate conditions. For example, the ammeter indicated the load on the motor, the rope meter shows the speed of the rope, and the temperature gauges show temperatures in the mine.



Closed Circuit TV provides a view of likely problem areas. The hoist operator is able to observe areas such as the loading pockets and the dumping area.

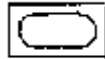

The specific use of a communication system varies from one mine to another. For example, in some mines the skip tender will telephone the hoist operator before giving a bell signal requesting the use of the hoist.

It is a safe practice for the hoist operator to acknowledge the bell signal prior to answering the request.

In general, basic bell codes are standard, but there are many variations among mines.

The mine hoist operator must be thoroughly familiar with the operating procedures for the communication systems of his/her mine.

## **STATE REGULATIONS:**

### METAL AND NONMETALLIC MINES

#### Signaling

There shall be at least two effective approved methods of signaling between each of the shaft stations and the hoist room, one of which shall be a telephone or speaking tube.

Hoist men shall accept hoisting instructions only by the regular signaling system unless it is out of order. During an emergency, the hoist men shall accept instructions only from authorized persons to direct movement of the conveyances.

A method shall be provided to signal the hoist operator from cages or other conveyances at any point in the shaft.

A standard code of hoisting signals shall be adopted and used at each mine. The movement of a shaft conveyance on a "one bell" signal shall be prohibited.

A legible signal code shall be posted prominently in the hoist house within easy view of the hoist men, and at each place where signals are given or received.

Any person responsible for receiving or giving signals for cages, skips and mantrips when men or materials are being transported shall be familiar with the posted signaling code.

### UNDERGROUND COAL MINES

There shall be at least two effective methods approved by the Department of signaling between each of the shaft stations and the hoist room, one of which shall be a telephone or speaking tube.

One of the methods used to communicate between shaft stations and the hoist room shall give signals which can be heard by the hoisting engineer at all times while men are underground.

Signaling systems used for communication between shaft stations and the hoist room shall be tested daily.



# MINE HOIST OPERATOR TRAINING SYSTEM

## UNIT

## LUBRICATION

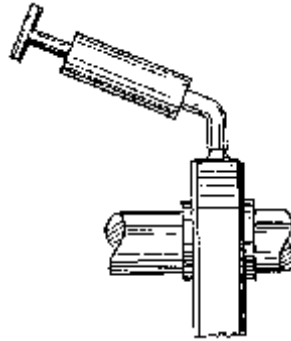

## OBJECTIVE

The trainee will know the methods, components and STATE regulations for lubrication.

## TIME

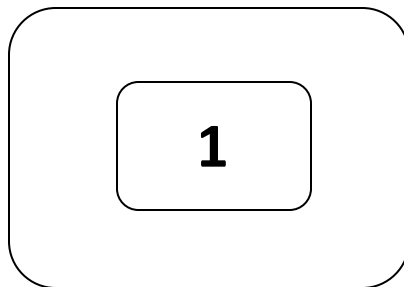

## INSTRUCTIONAL OBJECTIVES FOR LUBRICATION

The trainee will be able to write in one or two sentences, the function (use) of lubrication.

The trainee will be able to list three typical types of mine hoist parts that require lubrication.

The trainee will be able to list examples of each type of part that requires lubrication.

The trainee will be able to describe the methods of application for each type of lubricant. Given an illustration of the different lubrication systems where each of the parts is labeled with a letter, the trainee will be able to:

1. Label each system; grease gun, oil flow or oil reserve
2. Write the name of each labeled part

The trainee will be able to write the information that must be known for proper mine hoist lubrication.

The trainee will be able to answer, in writing, multiple-choice questions concerning the application of State regulations for lubrication.

## LUBRICATION

Lubrication prevents wear on surfaces that rub together and is a major part of machinery maintenance.

The typical parts of a mine hoist that require lubrication are:

- Bearings of all rotating parts
  - Hoist motor
  - Over-speed and over-travel control
  - Hoist drum
  - Air compressor
  - Head and other sheaves
  - Hydraulic pump
- Joints of operating mechanisms
  - Brake
  - Clutch
  - Safety dogs
  - Limit switches
  - Hoist operating controls
- Other surfaces that rub together
  - Shaft guides and conveyance guide shoes
  - Hoist rope

The types of lubricant are:

- Oil
- Grease

The methods of application are:

- Oil
  - Oil reservoir

The bearing or part to be lubricated is submerged in oil a dipstick or sight glass is provided to indicate if the oil is at the proper level. (See Figure 1)

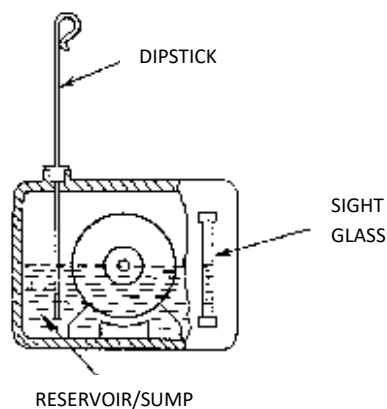

Figure 1

- Oil flow system

Oil is fed to the bearing from an elevated tank by gravity or by a pump. After flowing through the bearing, the oil drains into a sump. A pump takes the oil out of the sump and pumps it to an elevated tank or directly to the bearing. A sight glass is usually provided to show whether or not oil is flowing in the required amount. A sight glass or dip stick can be used to show if there is sufficient oil in the tank or sump. The gauge measures oil pressure. (See Figure 2)

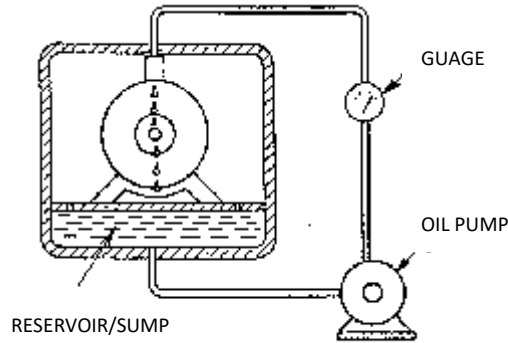

Figure 2

- Grease

Grease is forced between the parts to be lubricated (shaft and bearing, for example) by a grease gun. (See Figure 3)

The gun may be attached or portable. If it is attached, it may be operated automatically or manually.

An adequate supply of grease should always be in the gun.

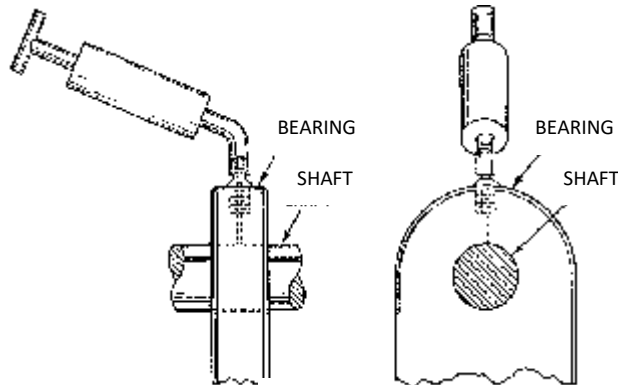

Figure 3

The person responsible for lubricating the hoist machinery must know:

- The parts to be lubricated
- The method of lubricating each part
- The type of lubricant (grade and weight of oil—type of grease) used for each part
- The location of the lubricant storage

The application of the lubricant to the shaft guides is usually done with a mop or brush.

The application of the lubricant to the hoist rope will be covered in that unit.

The manufacturers of practically all equipment include recommendations for lubrication in the instruction manual. These recommendations may be modified in your organization by the people responsible for maintenance. These instructions or modified instructions should be followed closely.

## **STATE REGULATIONS**

### **METAL AND NONMETALLIC MINES**

Complete records shall be kept of installation, lubrication, inspection, tests, and maintenance of shafts and hoisting equipment.

Ropes shall be kept well lubricated from end to end and recommended by the manufacturer.

Sheaves shall be inspected daily and kept properly lubricated.

Rollers used in inclined shafts shall be lubricated, properly aligned and kept in good repair.

# **MINE HOIST OPERATOR TRAINING SYSTEM**

## **UNIT**

# **ELECTRICAL SYSTEM (FUNDAMENTALS)**

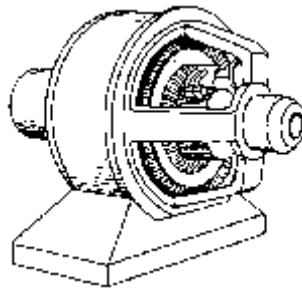

### **OBJECTIVE:**

The trainee will know the operating principles, major components and safety guidelines for the electrical system.

### **TIME**

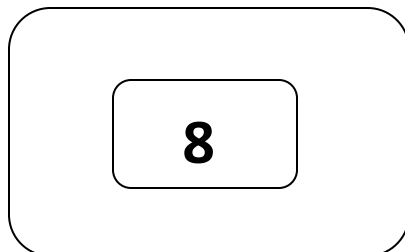

## **INSTRUCTIONAL OBJECTIVES FOR THE ELECTRICAL SYSTEM**

The trainee will be able to write in one or two sentences the function of the electrical system.

The trainee will be able to answer, in writing, questions concerning the basic principles of:

1. Electricity
2. Magnetism
3. Direct current motors
4. Alternating current motors
5. Direct current generators
6. Alternating current generators
7. Transformers
8. Fuses and circuit breakers
9. Work and power relationships
10. Safety precautions for electricity

The trainee will be able to solve simple problems using Ohm's Law.

## BASIC ELECTRICAL IMPULSES

Electricity provides energy for operating the mine hoist and other equipment and for lighting and heating. (See Figure 1)

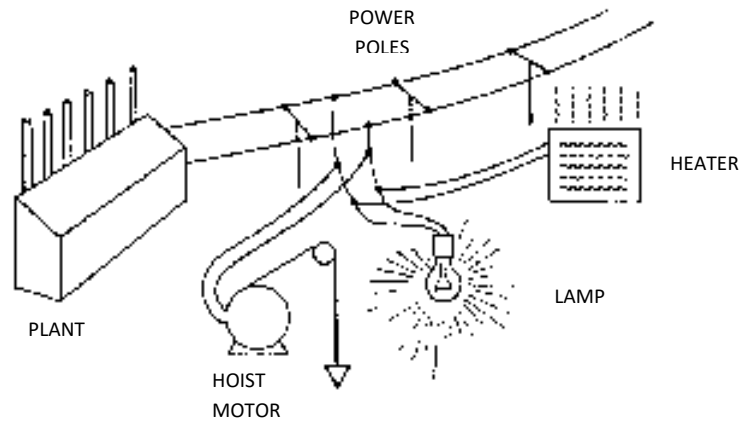

Figure 1

Like other forms of energy, electricity, if not carefully controlled, can cause injuries to people and damage to equipment.

Knowledge of the material in this unit will enable the hoist operator to operate the mine hoist and its supporting equipment with a high degree of safety from electrical hazards.

### ELECTRICITY

Electrical energy is created by a flow of negatively charged atomic particles called electrons. If there are more electrons at point A (Figure 2) than there are at point B, and there is a path (conductor) through which the electrons can flow, electrons will move from point A to B until an equal number is at each point. (Figure 3)

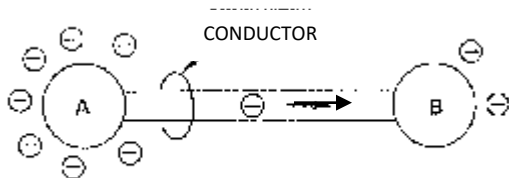

Figure 2

until an equal number are at each point (Figure 3).

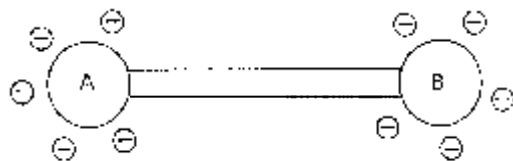

Figure 3



The excess number of electrons at 'A' in Figure 2 created a pressure, causing the electrons to flow to point B. you can compare the action to the two tanks of water in Figure 4.



Figure 4

The greater water pressure caused by the greater height of the water in A (H) will cause water to flow into B until the water in each tank is at the same height.

## PRESSURE AND CURRENT

### Volts and Amperes

In electricity the “pressure” causing the flow is called voltage. The rate of flow of electrons is called current.

A unit of voltage is one Volt.

Its symbol is E.

A unit of current is called one Ampere.

Its symbol is I.

It is important to remember that if there is a difference in voltage and a path along which electricity flow (a conductor) between two points, current will flow from the high voltage to the low voltage point.

### RESISTANCE – OHMS

In the water system resistance is a restriction that opposes the flow of water. For example, if we use a smaller pipe between the two tanks, the rate of flow of the water will be less than if we use a larger pipe. With the smaller pipe we have put a resistance to the flow of water in the path. (See Figure 5)

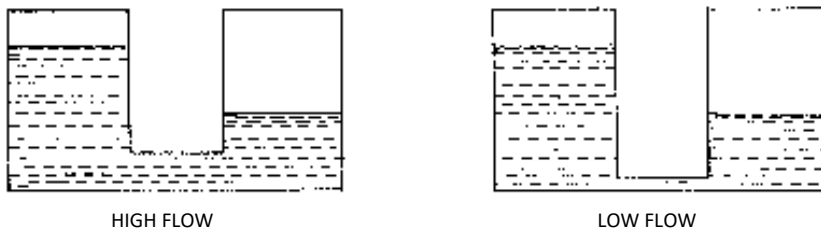

Figure 5

If we put a resistance in the path of the electrons (a smaller conductor or a conductor of a material that does not allow electrons to flow as well), Figure 6, the rate of flow of electrons will be reduced.

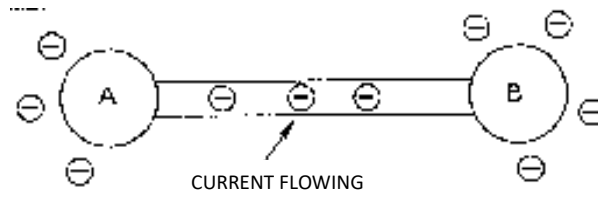

Figure 6

In an electrical circuit a unit of resistance to flow is an Ohm.

Its symbol is R.

**Now go to the Questions and answer 1 through 10**

There is a relationship between the number of volts, amperes, and Ohms in an electrical circuit. It is called Ohm's Law.

Here are the relationships:

Symbols

Volts = Amperes x Ohms       $E = IR$

Amperes =  $\frac{\text{Volts}}{\text{Ohms}}$        $I = \frac{E}{R}$

Ohms =  $\frac{\text{Volts}}{\text{Amperes}}$        $R = \frac{E}{I}$

These relationships enable us to find one unknown value if two others is known. For example, if we have 5 amperes flowing through a circuit with 10 ohms resistance, what is the voltage?

$E \text{ (Volts)} = I \text{ (Amperes)} \times R \text{ (Ohms)}$

Or,  $E = 5 \times 10 = 50 \text{ Volts}$ .

The circuit would look like Figure 7.

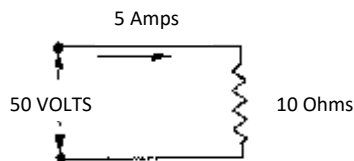

Figure 7

Or if we have 100 Volts across a 5 Ohm resistance (Figure 8), how many amperes are there?

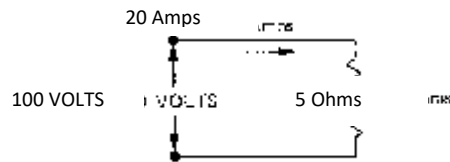

Figure 8

The current flow will be:

$$I = \frac{E}{R} = \frac{100}{5} = 20 \text{ Amperes}$$

And if we have 75 volts causing 25 amperes to flow in a circuit (Figure 9), what is the resistance in the circuit?

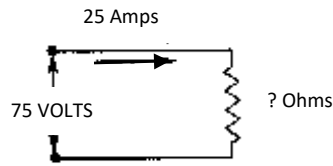

Figure 9

$$R = \frac{E}{I} = \frac{75}{25} = 3 \text{ Ohms.}$$

**Now go to the Questions and answer 11 through 17**

### SERIES AND PARALLEL CIRCUITS

There are two types of circuits: Series and Parallel. (See Figure 10)

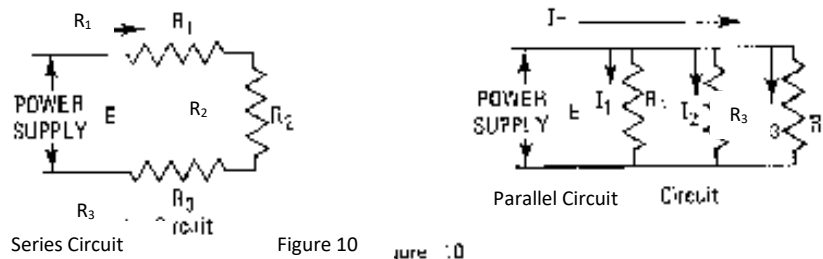

Figure 10

In a **Series** circuit the same amount of current flows through each resistance (or load) in the circuit. The total resistance in the circuit is equal to the sum of the resistances, that is  $R_T = R_1 + R_2 + R_3$ . The current flowing through each resistance is equal to the voltage (E) divided by that sum:

$$I = \frac{E}{R_1 + R_2 + R_3}$$

In a **Parallel** circuit the amount of current flowing through each resistance (or load) is equal to the voltage (E) divided by that resistance:

$$I_1 = \frac{E}{R_1} ; I_2 = \frac{E}{R_2} ; I_3 = \frac{E}{R_3}$$

$$\text{The total current } I_T = I_1 + I_2 + I_3$$

For example, in a 100 volt series there are 3 resistances (or loads), one of 5 Ohms, one of 8 Ohms, and one of 12 Ohms. What is the current flow?

$$I = \frac{E}{R + R + R} = \frac{100}{5 + 8 + 12} = \frac{100}{25} = 4 \text{ Amperes}$$

In a 100 volt parallel circuit we have three resistances (or loads), one of 5 Ohms, one of 10 Ohms, and one of 20 Ohms. How much current flows through each one? What is the total current?

$$I_1 = \frac{E}{R_1} = \frac{100}{5} = 20 \text{ Amps}$$

$$I_2 = \frac{E}{R_2} = \frac{100}{10} = 10 \text{ Amps}$$

$$I_3 = \frac{E}{R_3} = \frac{100}{20} = 5 \text{ Amps}$$

**Now go to the Questions and answer 18 and 19**

-----

### **CONDUCTORS AND INSULATORS**

Practically every substance will conduct electricity to some extent. Those that have low resistance are called Conductors; those that have high resistance are called Non-conductors. Non-conductors are used as Insulators.

Commonly used conductors are listed below from lowest to highest resistance:

- Silver
- Copper
- Gold
- Aluminum
- Carbon

Silver, of course, is used only in rare cases, and in very limited amounts because of its cost.

The best and most commonly used non-conductors are:

- Rubber
- Porcelain
- Glass
- Some plastics

There is no perfect conductor or non-conductor.

Most conductors are in the form of wire, made of copper or aluminum.

The diameter of the wire is given in thousandths of an inch or Mils. A wire with a diameter of 5 thousandths of an inch is a 5 Mil wire. The cross-section of the wire in Figure 11 is 5 Circular Mils.

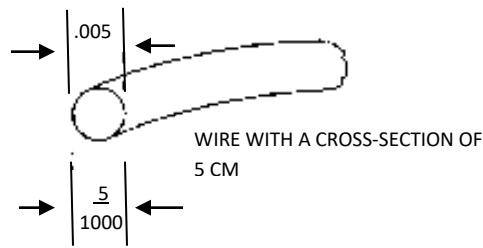

Figure 11

## ELECTRICAL POWER SYSTEMS

We can't actually see electricity flow through a wire and do the work for us. We can, however, readily understand its basic operating principles by comparing it to a simple power system that is easily understood.

An electrical power system is similar to a water power system. Figure 12 is a sketch of a water powered system. Water is stored behind the dam and creates a pressure to force water through the pipe. When the valve is opened water flows through the pipe and turns the water wheel. The greater the pressure, the greater the rate of flow of water. The greater the flow of water the greater the amount of power generated by the turning wheel.

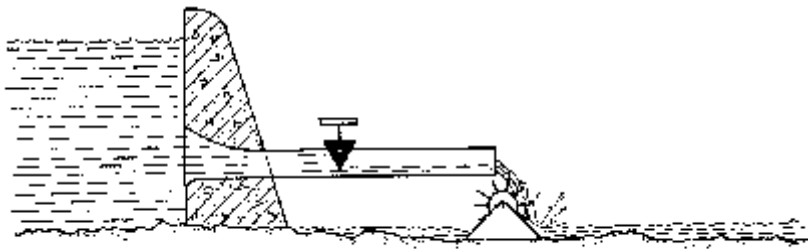

Figure 12

In an electrical power system, Figure 13, we have a similar situation. Electricity is like the water. It comes from a battery or generator and flows through wires or conductors. Remember that the pressure that forces it through the conductors is the voltage and the rate of flow of electricity is the current. Voltage is measured with a Voltmeter; current is measured with an Ammeter. (See Figure 14) The greater the number of volts, the greater the number of amperes and the greater the amount of power, light, or heat that is generated.

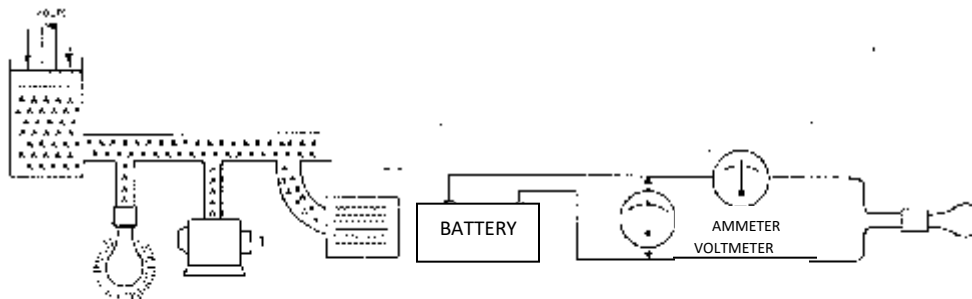

Figure 13

Figure 14

Too much pressure in a water system will increase the flow of water to the point that the pipes or equipment will be damaged. (See Figure 15)

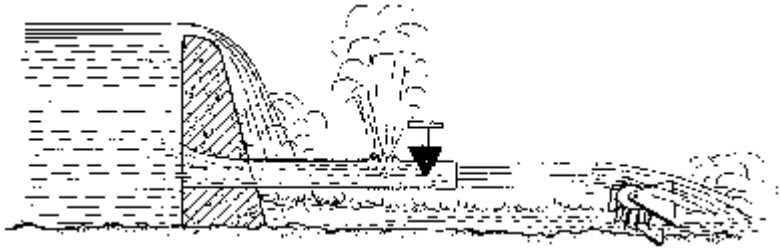

Figure 15

Too much voltage in an electrical system will increase the current to the point that the conductors or equipment will be damaged. (See Figure 16)

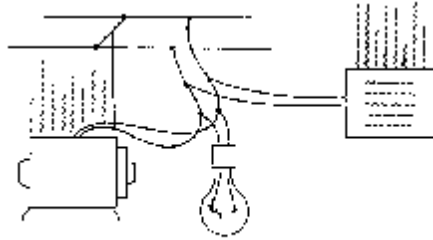

Figure 16

### **POWER - WATTS**

For our purpose, Power is the rate at which a motor or engine does work. Power is equal to the pounds lifted multiplied by the number of feet the pounds were lifted, divided by the number of seconds that it took to do the lifting.

$$\text{Power} = \frac{\text{Pounds x Feet}}{\text{Seconds}}$$

A basic unit of power is foot pound per second. If a hoist lifts one pound one foot in one second, it is exerted one foot pound per second of power. (Figure 17)

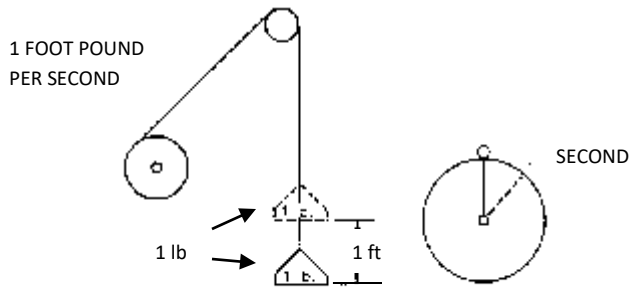

Figure 17

If the hoist lifts 5 pounds 10 feet in 2 seconds, it used 25 foot pounds per second of power. (Figure 18)

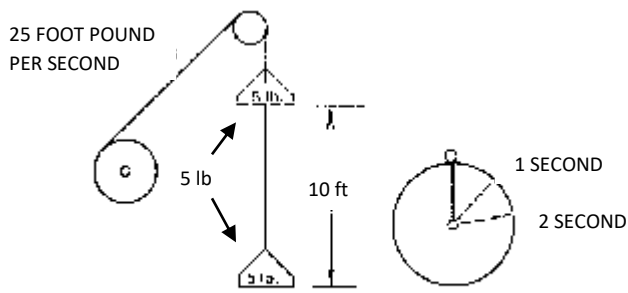

Figure 18

**WORK**

The work done by the motor or engine is equal to the pounds that were lifted or force that was exerted, multiplied by the distance the pounds were lifted, or the distance through which the force was exerted.

$$(Work = Pounds \times Feet)$$

If we lift 1 pound 1 foot, we do 1-foot pound of work. If we lift 1 pound 3 feet, we do 3-foot pounds of work. If we lift 2 pounds 3 feet, we do 6-foot pounds of work. (Figure 19)

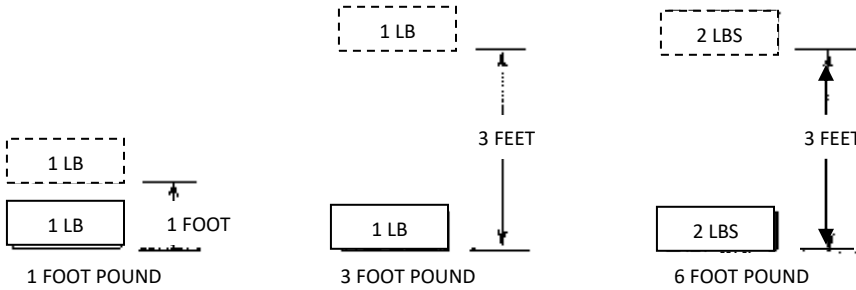

Figure 19

**WORK AND POWER**

We can also determine the amount of work done by multiplying the power exerted by a motor or engine by the same time that it operated (Work = Power x Seconds). For example, the hoist in Figure 18 raised 5 pounds 10 feet in 2 seconds. It did 50 pounds of work in 2 seconds, or 25-foot pounds each second.

$$25\text{-foot pounds per second of power} \times 2 \text{ seconds} = 50\text{-foot pounds of work}$$

**HORSEPOWER**

Horsepower is a common term used to express power. One horsepower is the power needed to do 550-foot pounds of work in one second- or 33,000-foot pounds of work in one minute. If a hoist has a 100-horsepower motor, it could do (550 x 100) foot pounds of work in one second, that is 55,000-foot pounds. It might lift 550-pound weight 100 feet in one second- or 55,000-pound weight one foot in one second. (Figure 20)

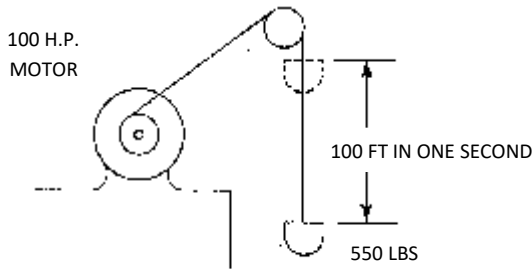

Figure 20

Electric Motor: using 50 amps of current and operating on 440-volt, AC.

$$\frac{P}{I \times E} = P = I \times E = P = 50 \text{ amps} \times 440 \text{ volts}$$

$$P = 22,000 \text{ watts}$$

$$1 \text{ hp} = 746 \text{ watts}$$

$$HP = \frac{22,000}{746}$$

$$HP = 29.49 \text{ HP}$$

In one minute the 100 HP motor could hoist a 33,000 pound weight 100 feet.



Suppose your production hoist has two skips and tail ropes. The hoist will lift 15,000 pounds x 2,200 feet per minute, if you ignore friction losses, how many horsepower are needed to run the hoist?

The work to be done in one minute is: 15,000 pounds x 2,200 feet = 33,000,000 foot pounds.

To convert the 33,000 foot pounds per minute to horsepower, divide the 33,000,000 foot pounds per minute by 33,000 foot pounds per minute for each horse power

$$\text{Power required is} = \frac{33,000,000}{33,000} = 1,000 \text{ horse power}$$

We can find out how much work the motor has done by multiplying the power by the time that the power is used. For example, if the above hoist operates for 10 minutes, it will do 1,000 x 33,000 or 330,000,000 foot pounds of work.

-----

### **WATTS, KILOWATTS AND KILOWATT HOURS**

Power for electrical machinery is expressed in Watts.

When one volt causes one ampere current to flow in an electrical circuit, one watt of power is used. The symbol for Power is P. The power may hoist ore, turn a fan, pump water, light a lamp, or provide heat. Since the watt is a very small unit, we usually use the term Kilowatt, this is, 1,000 watts. If one watt machine operates for one hour it will do one watt hour of work, or you can say that it used or expended one watt hour of energy. If a 10 Kilowatt machine operates for one hour, it does 10 Kilowatt hours of work.

Electric power used can be calculated by multiplying the voltage times the current flow, that is,  $P = E \times I$ . If 100 volts causes 5 amperes to flow in a circuit, the power used is  $P = E \times I = 100 \times 5 = 500$  Watts. If the voltage and current flow continues for 2 hours, 1,000 watt hours of work (one Kilowatt hour) is done. The power company bills the consumer on the number of Kilowatt hours of energy used.

### **WATT HOUR METER**

A Watt Hour Meter is used to measure the power or energy used. The watt hour meter actually measure the voltage and the amperage and combines the two measurements along with a time factor through a mechanical linkage in the meter.

Thus work or energy used = Volts x Amperage x Hours

### **RESISTANCE AND POWER**

We can use the Ohm's Law relationships on page I-A-20 to develop a similar formula for determining power. For example, we had:

$$P = E \times I$$

If we replace E with its formula ( $E = IR$ ) from page I-A-20-4, we have  $P = I \times R \times I$ , or  $I^2 \times R$ . thus if we have 5 amperes flowing through a circuit with 40 Ohms resistance, the power used in the circuit is:

$$P = I^2 \times R = 5 \times 5 \times 40 = 1000 \text{ Watts}$$

-----

The power that is used when current flows through the resistance in conductor turns into heat and is usually wasted. This fact creates two problems: one problem is the loss of power in transmission from the power company to the customer; the other problem is the creation of a fire hazard.

### **TRANSMISSION OR LINE LOSSES**

Suppose the mine receives power from one Power Company. The power company sends 100,000 watts at 1,000 volts and 100 amperes. Assume that the power lines have a resistance of 2 ohms.

In this case there will be a power transmission loss (line loss) of  $I^2 \times R = 100 \times 100 \times 2$ , or 2,000 watts. Thus while the power company sent 100,000 watts, we only receive 80,000.

If the power company sent the power at 2,000 volts and 50 amperes, the transmission or line loss would only be:  $I^2 \times R = 50 \times 50 \times 2$ , or 5,000 watts, and 95,000 watts would be received instead of 80,000.

Since line losses increase very rapidly as we increase the current, electricity is usually transmitted at very high voltage and low amperage.

The problem of a fire hazard is created when there is a poor connection, too small a conductor, or a damaged conductor between the power supply and the load that creates additional resistance. For example, a motor draws 10 amperes at normal load. If there is a bad connection in the conductor to the motor controls or switch boxes, the resistance at that point increases. For each ohm that it increases, 100 watts of power are lost and turn into heat.

$$P = I^2 \times R = 10 \times 10 \times 1 = 100$$

The heat may burn the insulation off the conductor, ignite flammable materials in the vicinity and start a fire.

-----

# ELECTRICITY AND MAGNETISM

The hoist motor and motor generator operate as they do because of certain relationships between electricity and magnetism. This section will explain those relationships.

If direct current electricity flows through a coil of wire that is wrapped around a piece of iron ("core") in the direction shown by the arrow →, the iron will become a magnet. The magnetic lines of force are indicated. The magnet's North and South Poles will be as indicated by S and N. (See Figure 21). This kind of magnet is called an electromagnet since it is created by electricity.

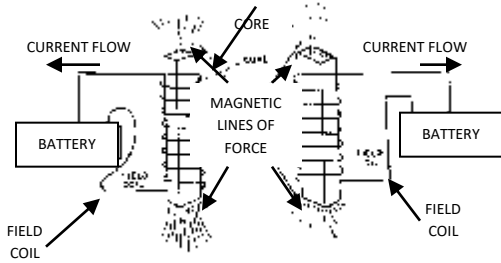

Figure 21

If the number of wire turn or the current flow through the turns is increased, the strength of the magnetic field will be increased. (See Figure 22)

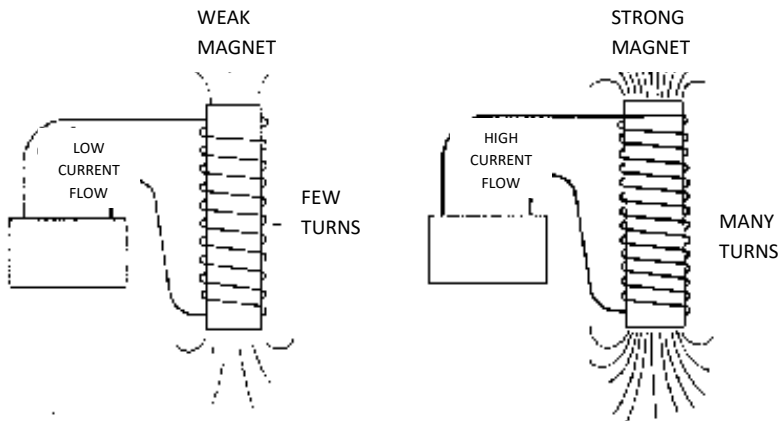

Figure 22

Opposite poles, N and S, attract each other. (See Figure 23) Like poles, N and N or S and S repel each other. (See Figure 24)

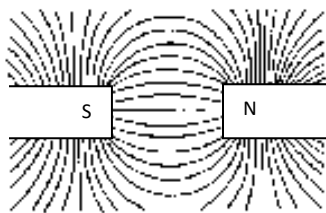

Figure 23

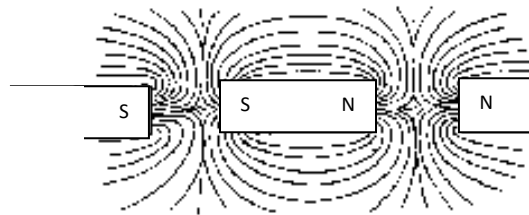

Figure 24

There are electromagnets inside the mine hoist motors. The attracting and repelling forces between the magnets cause the shaft of the hoist motor to turn.

In Figure 25A, a wire is passed from left to right through magnetic field. A voltage is generated in the wire. If the two ends of the wire are connected, current will flow.

In Figure 25B, the direction of motion of the wire through the magnetic field is from right to left. The current flow is in the opposite direction from Figure 25A.

In Figure 25C the position of the poles of the magnetic field are opposite to those in Figure 25A. Changing the position of the poles changes the direction of current flow.

If the strength of the field is increased and/or the speed of the wire passing through the field is increased, the voltage generated is also increased.

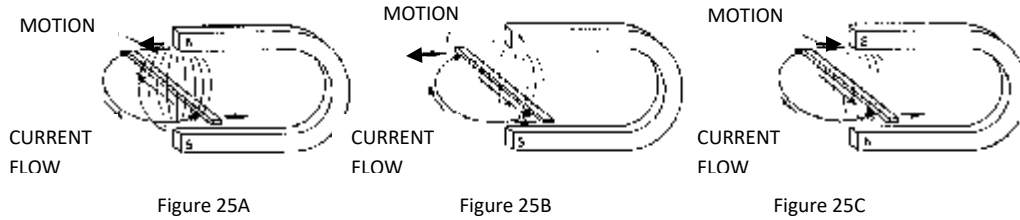

The voltage in the wire changes as the wire passes through a magnetic field. It is:

- Low on entering the field
- At a peak in the center of the field
- Low on leaving the field (See figure 26)

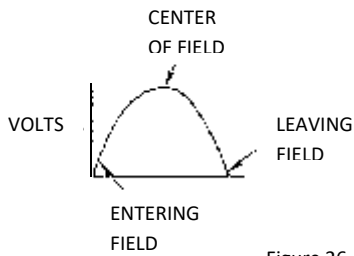

The generator that supplies power to the hoist motor operates on these principles. Control of the hoist motor is also affected by these principles.

There are two kinds of electricity: Direct Current and Alternating Current. With direct current the voltage causes the current to flow in one direction only. The voltage may vary in the amount but not in the direction. (See Figure 27)

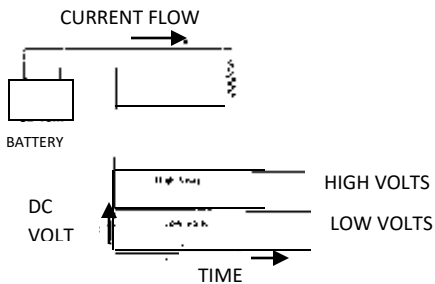

Figure 27

For alternating current the voltage causes the current to flow first in one direction, then in the opposite direction. The voltage starts at zero, rises to a peak in one direction, drops to a zero then to a peak in the opposite direction, then rises back to zero. (See Figure 28)

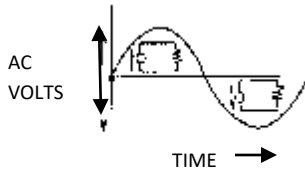

Figure 28

Most commercial electricity is generated and transmitted to the customer as alternating current. Some mine hoists and other mine equipment operate on alternating current while others operate on direct current. Where direct current is used the alternating must be changed to direct current. A motor generator set (alternating current motor driving a direct current generator) or a rectifier is used for this purpose. (See Figure 29)

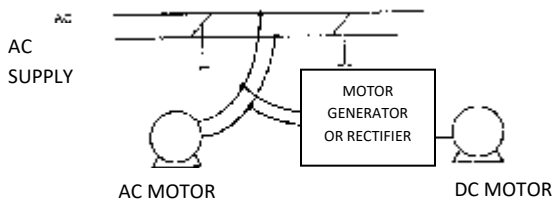

Figure 29

### **DIRECT CURRENT VS. ALTERNATING CURRENT**

There are advantages and disadvantages in using both AC and DC current:

- Alternating current is more dangerous: 1/10 ampere of alternating current gives a fatal shock; however, it takes five times as much direct current (1/2 ampere) to give the same shock.
- The voltage of alternating current can be raised or lowered with very little loss in a simple transformer; changing direct current voltage requires complex electronic circuits.
- Direct current voltage can be lowered by passing it through a Rheostat, a resistance whose value can be changed; however, this procedure wastes power.
- The speed and power output of direct current motors can be adjusted and varied much more simply and efficiently than the speed and power output of alternating current motors.

## ELECTRIC MOTORS AND GENERATORS

The hoist motor changes electrical Energy into rotary motion. The generator that supplies power to the hoist changes rotary motion into electricity. A generator may also be called a Dynamo. Since there are difference between alternating current and direct current motors and generators, we will describe them separately.

Direct Current Motor: It has four principle parts: (See Figure 30)

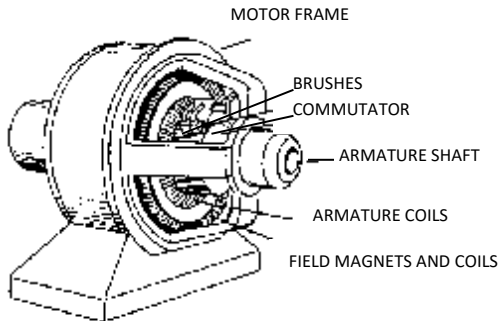

Figure 30

1. The Field Magnets, which are mounted in the motor frame. The field magnets are electromagnets (that is, cores wrapped in coils of wire).
2. The Armature, which is the rotating part of the motor and mounted inside the motor frame. The armature consists of several electromagnets (cores with their coils) mounted on a shaft.
3. The Commutator, which is a series of segments of a circle arranged around and attached to the armature shaft. Each segment is connected to one of the armature's electromagnet coils.
4. The Brushes, which are attached to the motor frame and touch the commutator. They provide a path for electricity from the power supply through the commutator to the electromagnet coils in the armature. (See Figure 31)

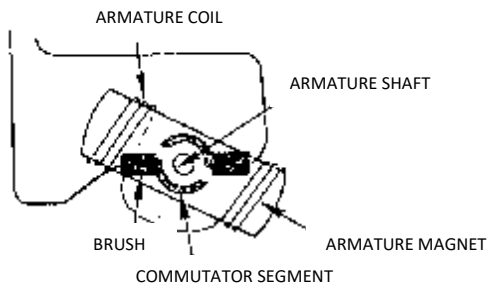

Figure 31

A Direct current Motor operates on these principles:

- If we reverse the flow of current through the coil of an electromagnet, the poles of the magnet are reversed.
- Opposite poles attract each other.
- Like poles repel each other.

Industrial motors, like the one in Figure 30, have several armature magnets with the two commutator segments for each one. They may also have more than one field magnet. In order to explain the operation of a direct current motor we will use a simple motor which has only these parts.

- One field magnet
- One armature magnet
- Two commutator segments

Note: In Figure 32 through 34, the poles of the field magnet DO NOT change.

In Figure 32 the armature poles are the same. The nearest field poles, therefore, are being repelled, causing a clockwise rotation of the armature.

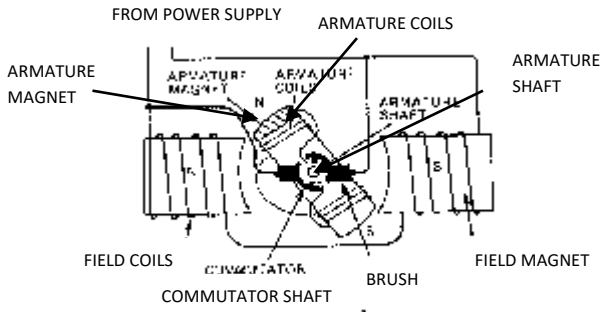

Figure 32

In Figure 33, the armature has continued its clockwise movement and the armature poles are being attracted by the opposite field poles.

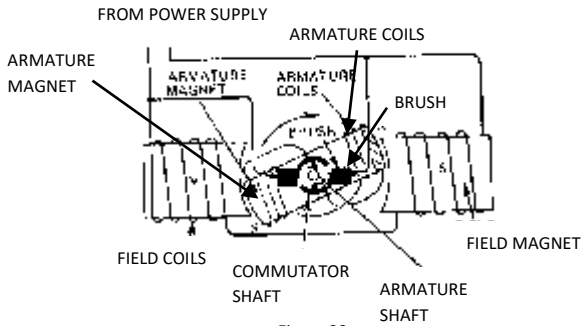

Figure 33

In Figure 34, the armature has passed through the horizontal position and the brushes have switched to opposite segments of the commutator. Current flow in the armature coils is reversed; the armature poles are reversed and are now being repelled by the field poles to continue the clockwise motion. The rotary motion of the armature can be used to turn the hoist drum, hydraulic pump and other machinery.

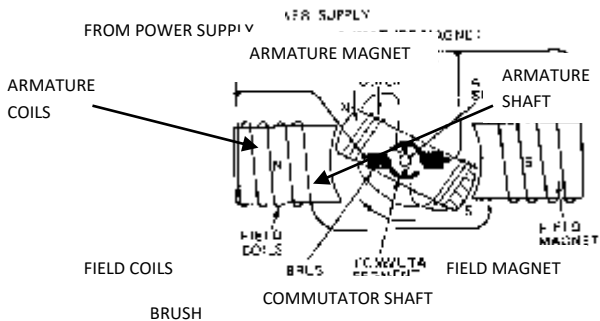

Figure 34

Increasing or decreasing the armature current will increase or decrease the magnetic forces which turn the armature and therefore, increase or decrease the power output of the motor. (See Figure 35) A direct current motor is reversed by changing the direction of current flow in either the armature or the field coils.

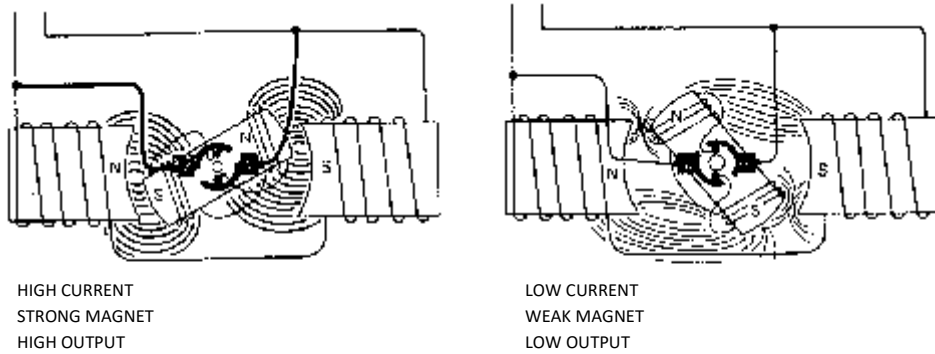

Figure 35

The brushes of a DC motor are made of either carbon or copper. Copper is a better conductor and wear longer. However, it is fairly hard and causes more wear on the motor commutator. Carbon brushes cause little commutator wear; however, they do chip and cause sparking, and they need to be replaced more often. Each brush usually has a wire (Pigtail) attached which is connected to the power supply.

The position of the brushes is very critical. If the voltage on the brush and the voltage of the commutator segment, passing under the brush, are not nearly equal, sparking will occur. Changing position of the brush will help correct this defect. A worn commutator or broken brush will also cause sparking.

### DIRECT CURRENT GENERATOR

A direct current generator has the same parts as a direct current motor.

- Direct current from an outside source flows through the field coils.
- A power source, turbine, diesel or gasoline engine, or motor turns the armature.
- As the armature coils pass through the magnetic fields a voltage is generated in the coils. This causes the current to flow in the coils.
- The current flows to the commutator and through the brush circuit to the machine, light or appliance where it will be used. (See Figure 36)

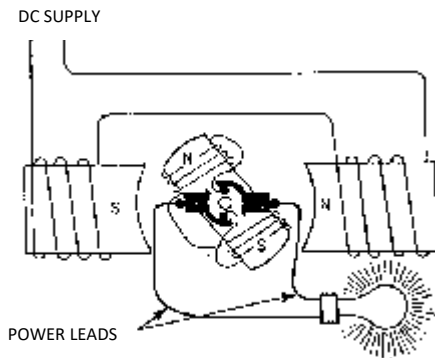

Figure 36



- Increasing the strength of the magnetic field and/or increasing the speed of the armature increases the generated voltage. (See Figure 37)

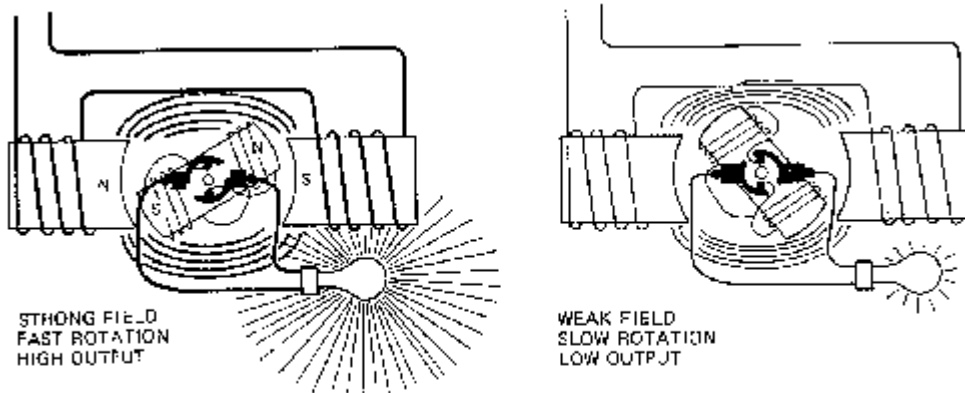

Figure 37

The voltage generated in the coils reverses itself each time that it passes different pole. This would cause alternating current to flow. (See Figure 38)

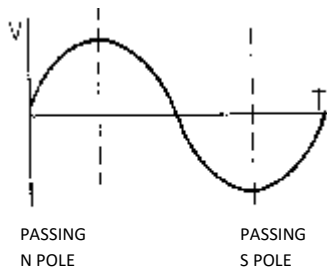

Figure 38

However, the commutator switches the end of the coils from one power lead to another as the voltage reverses itself. The switching keeps the voltage in the power leads going in the same direction. (See Figure 39)

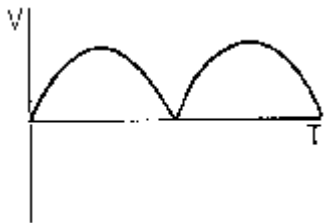

Figure 39

Industrial generators have many armature coils and the current flows into the power leads at peak voltage. The output has little more than a slight ripple. (See Figure 40)

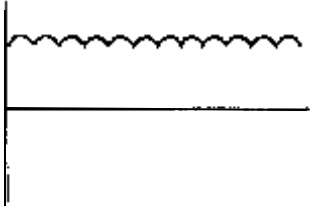

Figure 40

### ALTERNATING CURRENT GENERATOR

In a direct current generator a magnetic field was created in the field coils and voltage was generated in the armature coils. (See Figure 41)

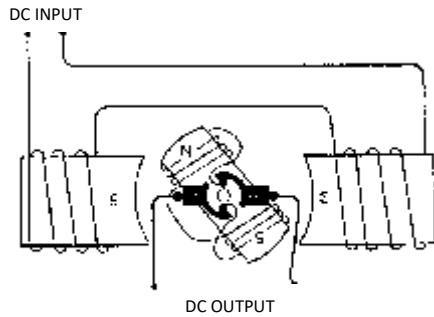

Figure 41

In an alternating current generator the magnetic field is created in the armature. DC current flows into the armature coils through slip rings. As the armature turns, voltage is generated in the field coils. (See Figure 42)

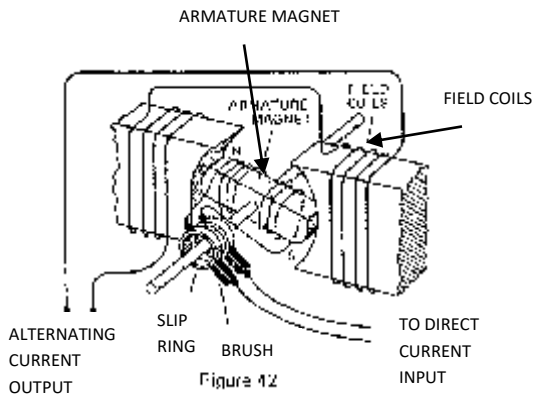

Figure 42

The output of three phases looks like Figure 45.

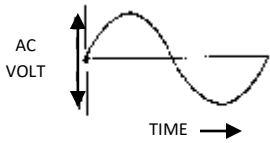

Figure 43

An industrial AC generator has 3 pairs of poles (See Figure 44). Each pair is independent of the other pairs. The output of each pair (Figure 44) is called a phase. The output of each phase is like Figure 43.

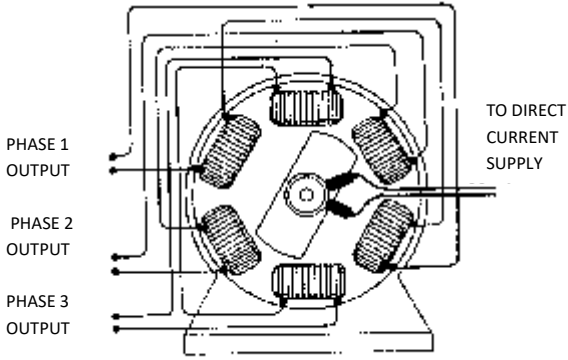

Figure 44

The output of the three phases looks like Figure 45.

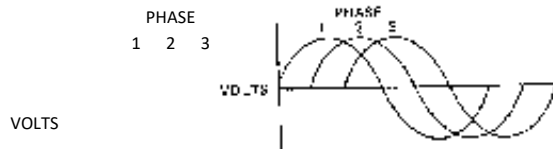

Figure 45

The stronger the magnetic field and the faster the armature rotation, the higher the voltage and current flow.

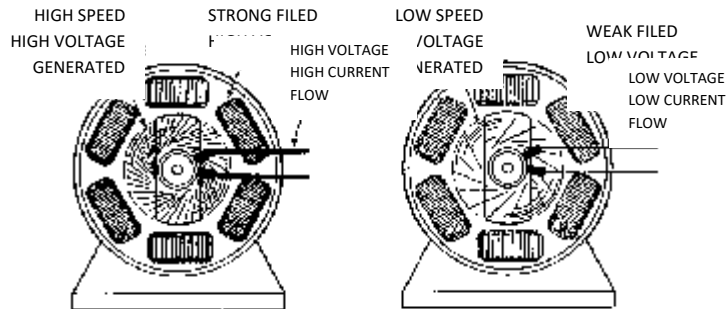

Figure 46

## ALTERNATING CURRENT MOTOR

An alternating current motor has a frame and field coils that are just like those of an alternating current generator. (See Figure 44)

The coils of a large alternating current motor would be connected to the corresponding coils of the generator.

The voltage in the generator coils will cause current to flow through the motor coils and create magnetic fields. The fields will change poles successively and create a rotating field inside the motor frame. (See Figure 47A through D)

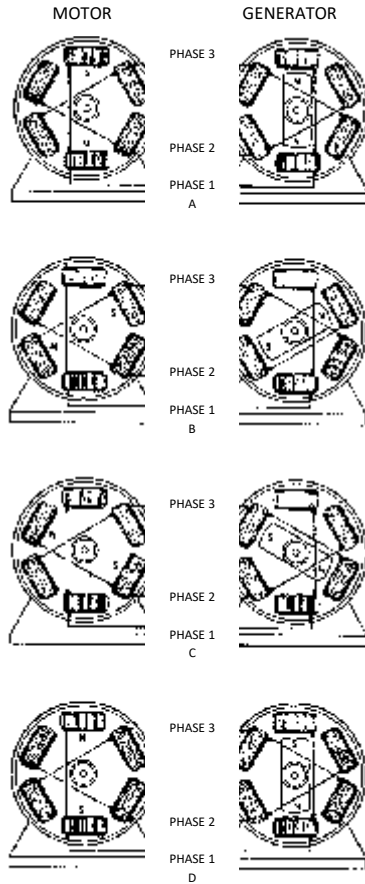

Figure 47

The armature of an alternating current motor is a core with a coil of wire. The ends of the coil are connected together. (See Figure 48)

As the motor field passes over the armature, a voltage is generated (or induced) in the armature coil, and current flows and creates a magnet. The magnet is attracted by the rotating field and rotates with it.

The voltage is induced in the armature coil only if the rotating field rotates faster than the armature does. The difference in armature rotation speed and field rotation speed is called **Slip**.

The more slip the more voltage is generated, and the stronger the armature magnet becomes. If the magnet is stronger, the motor rotates faster or with more force.

Slip	Armature Voltage Generated	Armature Current Flow	Armature Magnet Strength	Power Output
High	High	High	High	High
Medium	Medium	Medium	Medium	Medium
Low	Low	Low	Low	Low

---

### HOIST MOTOR SPEED CONTROL

The speed of a mine hoist motor need to be controlled. The speed of the alternating current motor, like the direct current motor, depends on armature current. In a mine hoist AC motor, armature resistances are placed in the armature coil circuits. Te resistances can be bypassed by closing switches. (See Figure37)

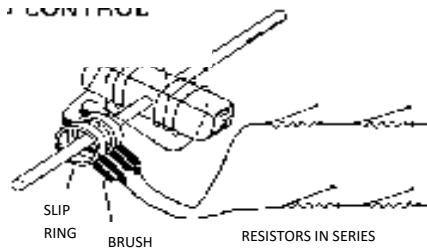

Figure 48

When starting the AC Motor, all of the switches are open and the armature circuit has maximum resistance. At this time, slip is at a maximum and the generated voltage is high. The high resistance keep the armature current low. If the resistance were not in the circuit, the armature current might get too high and damage the motor.

As the armature picks up speed, slip, voltage, and the current flow all decline. The switches are closed, one by one, to allow additional current to flow through the armature coils. The armature continues to pick up speed until all of the switches are closed. The motor is then running at its best speed for the amount of work that it is doing.

To slow armature the switches are opened one by one. This action:

- Increases the resistance of the armature circuit.
- Reduces the flow of current through the armature coils.
- Reduces the strength of the armature magnets.
- Causes the armature to slow down.

In a mine hoist the resistances are normally located in the hoist control room. The switches are in the hoist motor control box and are opened or closed by turning the motor controller. The switches and resistances are connected to the armature coils through slip rings and brushes.

Note that if we exchange the connections of two phases of the motor with the two phases of the generator, the direction of rotation of the magnetic field will be reversed. This is how an AC motor is reversed.

## STARTING DIRECT CURRENT MOTORS

When the armature of a DC motor is turning, a voltage is generated in the armature coil as the coil passes through the motor's magnetic field. This voltage opposes the voltage from the power supply. The voltage causing current to flow in the armature coils is equal to the difference between the power supply voltage and that being generated in the armature coils.

When the armature is not turning all of the power supply voltage is causing current to flow. If the power supply voltage is too high, too much current will flow. Therefore, the voltage first applied to the armature should be low. It is increased slowly as the motor picks up speed and begins to generate the opposing voltage.

The motor is at full speed when the power supply voltage is at its maximum.

If the voltage, to a running DC motor, drops, the armature may slow down and stop. In this condition, there may be enough voltage remaining to force enough current through the armature to burn the armature coils.

The voltage to the armature in a mine hoist motor is increased or decreased by strengthening or weakening the magnetic field of the DC generator, or by changing the output voltage of the rectifier.

### Types of Direct Current Motors

A Shunt Motor is shown in Figure 49.

The field coil and armature (through the brushes) are both connected across the power supply. They are in **parallel**.

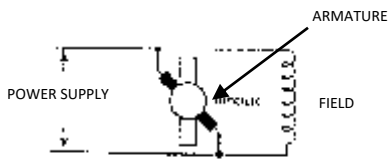

Figure 49

A Series Motor is shown in Figure 50.

One terminal of the field coil is connected to one terminal of the armature. The two are then connected across the power supply. The armature and field coils are in a **series**.

FIELD

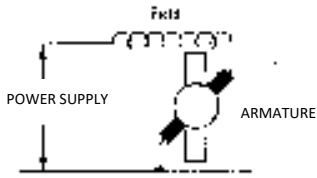

Figure 50

A Compound Motor is shown in Figure 51.

The motor has two fields, a shunt field and a series field. If the connections of the series field in a compound motor becomes reversed, as the motor starts it will rotate in one direction. As the armature current and the series field current increases, the series field will overpower the shunt field and cause the motor to reverse itself.

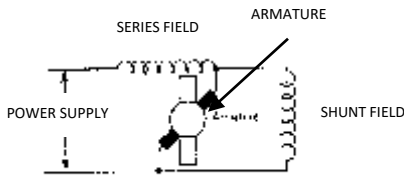

Figure 51

-----

### HOIST OPERATION

Figure 52 shows a sample sketch of a mine hoist electrical system with an alternating current motor. It functions as follows:

- Alternating current power comes from the power company to the switch board and through the hoist power switch to the hoist control.
- The hoist control does two things:
  - It sends power to the alternating current motor fields, and
  - It controls the amount of resistance in the armature and resistor circuit.
- When the hoist motor starts there is a high resistance in the armature and resistor circuit. The resistance is lowered as the motor picks up speed.

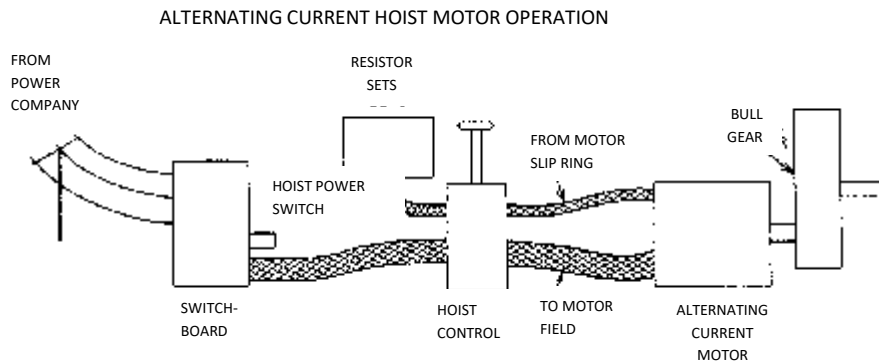

Figure 52

Figure 53 is a simple sketch of a mine hoist electrical system with a direct current hoist motor and a motor generator set. It functions as follows:

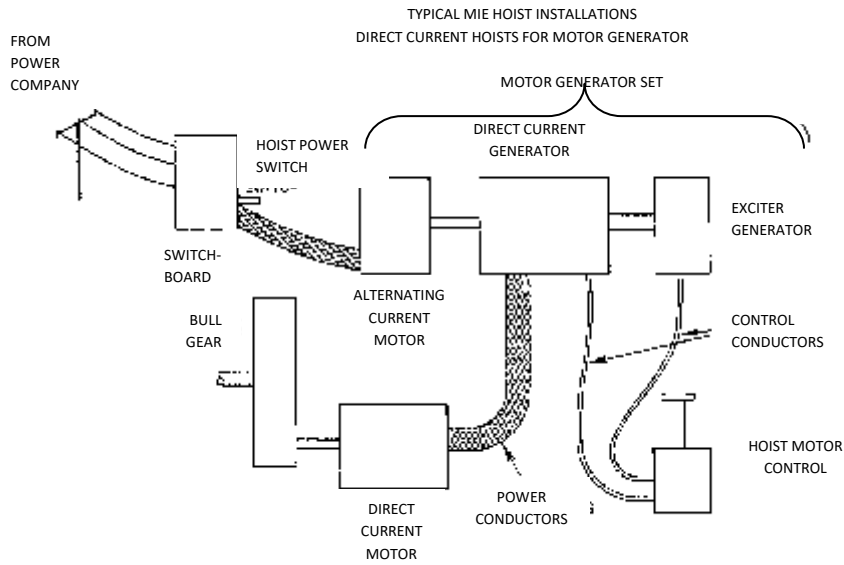

Figure 53

- Alternating current power from the power company goes to the switchboard and through the hoist power switch to the alternating current motor of the motor generator set.
- The alternating current motor drives the direct current generator and the exciter generator.
- The exciter generator is a small direct current generator that provides the current for the main generator magnetic fields.
- The output of the exciter generator goes to the hoist motor control then to the direct current generator fields.
- The hoist motor control is a switch that controls the direction and the amount of current that goes to the generator fields.
- The condition of the DC generator fields will determine the direction and amount of current that will be delivered to the hoist motor.
- The output of the main generator drives the hoist motor.



Figure 54 shows a simple sketch of mine hoist electrical system with a direct current motor and a rectifier power supply. It functions as follows:

- Alternating current power goes through the switchboard to the hoist power switch, then to the rectifier.
- The rectifier changes the alternating current to direct current.
- The hoist motor control causes the rectifier to send current at the required voltage and in the proper direction to the hoist motor.

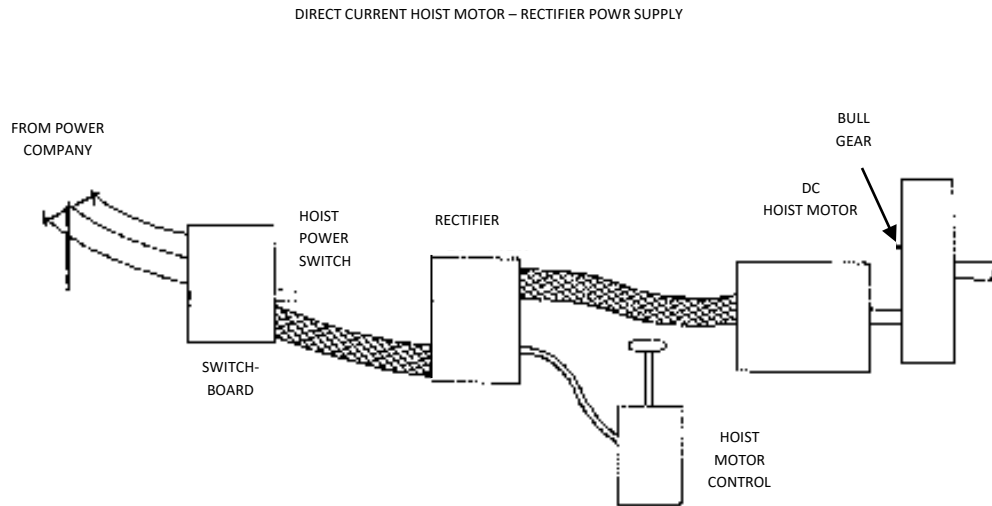

Figure 54

### USING THE MOTOR AS A BRAKE

An electric motor may be used as a brake to control the speed of the machine that it drives. This feature may be used in a mine hoist, for example, to slow the conveyance when lowering a heavy load and when approaching the designated landing.

In a direct current motor the armature voltage is reduced below that of the opposing voltage being generated in the motor armature. The overall voltage then is forcing current to flow out of the motor armature rather than into it. In effect, the motor is now a generator. The energy required to generate the current acts as a brake on the motor armature and causes it to slow. The current that flows back can be sent back to the power company through the motor generator.

In some alternating current motor, the motor is simply reversed. When lowering, for example, the hoist motor control is placed in the hoist position. The rotating field starts to rotate in the opposite direction and will slow the rotation speed of the armature.

In other alternating current motors, a switch is provided to substitute direct current for alternating current in one or two of the phases. Voltage is then generated in the armature coils as they rotate in the newly created magnetic field. The voltage is absorbed in the starting resistances. The energy thus absorbed acts as a brake on the motor armature.

The use of the motor as a brake is sometimes referred to as Dynamic Braking.

## TRANSFORMERS

The relationship between electricity and magnetism are used in another electrical machine called a “transformer.” The transformer changes the voltage of alternating current. If it raises the voltage it is a step-up transformer. If it lowers the voltage it is a step-down transformer.

You might ask, “Why do we want to change the voltage?” We want to change the voltage because for some applications high voltage is preferred and for others, low voltage. For example, transmission losses are lower if electric power is transmitted at a high voltage and low current (we covered that in a previous section). However, at the point where electricity is used, that is, generated and/or handled, this high voltage is more dangerous than low voltage. (Remember that voltage is the pressure causing current to flow). High pressure/voltage may cause current to flow in places where it is not wanted, such as between poorly insulated conductors to the machinery frame. High voltage may also cause sparking on motor commutators. It may also be a source of fire or damage to motors, heaters, lights, controls and other equipment. Therefore, it is safer and more economical to have low voltage where the power is generated and used, and to have high voltage where power is transmitted.

Here is what the inside of a transformer looks like: (Figure 55)

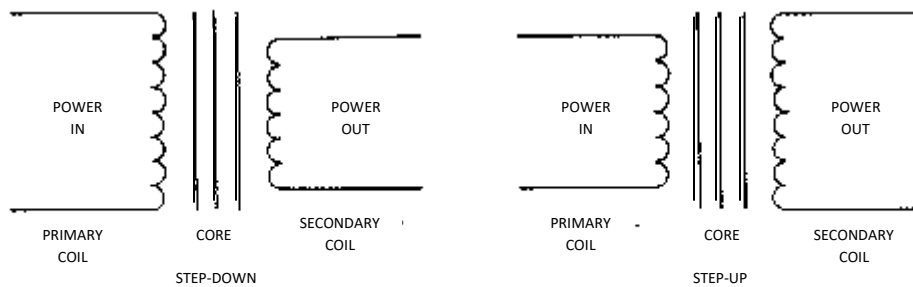

Figure 55

A transformer consists of two coils with a common core. Alternating current flows into the primary coil in one direction and makes a magnet out of the core. The buildup of magnetism in the core causes a voltage to be generated in the secondary coil. As the current reverses itself in the primary coil, the magnet is reversed and causes a reverse voltage to be generated in the secondary coil. Thus, the alternating current flowing into the primary coil generates a voltage which causes current to flow in the secondary coil.

Since power losses in a transformer are very small, for the purpose of this explanation we will consider them to be zero, the power flowing into the primary coil ( $P_p$ ) is equal to the power flowing out of the secondary coil ( $P_s$ ).

The voltage going into the primary coil ( $E_p$ ) and the voltage going out of the secondary coil ( $E_s$ ) are proportional to the number of turns of wire in each coil ( $N_p$  for the primary and  $N_s$  for the secondary). Suppose we have a transformer like this one, Figure 56.

Primary

$P_p$  – Power = 1000 Watts

$N_p$  – Turns = 100

$E_p$  – Volts = 100

$I_p$  – Amperes = ?

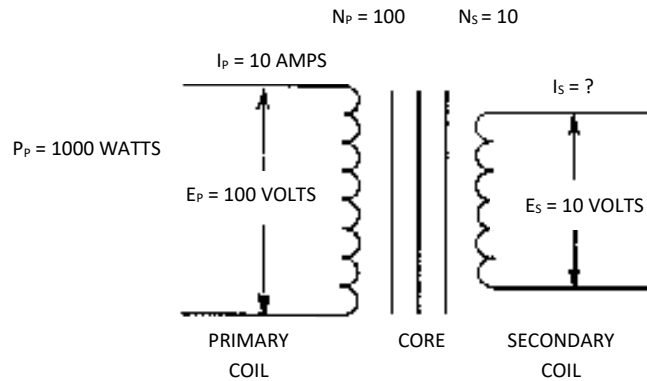

Figure 55

Secondary

$P_s$  – Power = ?

$N_s$  – Turns = 10

$E_s$  – Volts = ?

$I_s$  – Amperes = ?

Since we know the power and volts into the primary, and the number of turns in both the primary ( $N_p$ ) and secondary ( $N_s$ ), we can solve for the unknown values. For example, Primary current ( $I_p$ ):

1000 watts going into the primary at 100 volts;

$$P_p = E_p \times I_p; P_p = 1000; E_p = 100$$

$$\text{Then; } I_p = \frac{P_p}{E_p} = \frac{1000}{100} = 10$$

Secondary Power ( $P_s$ )

Since there are 1000 watts of power going into the primary ( $P_p$ ), there must be approximately 1000 watts of power from the secondary ( $P_s$ ).

Secondary Voltage ( $E_s$ )  $P_p = P_s; P_s = 1000$  watts

Since there are 100 volts and 100 turns in the primary  $E_p$  and  $N_p$ , and 10 turns in the secondary  $N_s$ ,

$$\frac{E_p}{N_p} = \frac{E_s}{N_s} \text{ or}$$

$$\frac{100}{100} = \frac{E_s}{10} \text{ or } E_s = \frac{100}{100} \times 10 = 10 \text{ volts}$$

Secondary Current ( $I_s$ )

Since there are 1000 watts of power in the primary ( $P_p$ ), there are also (for our purpose) 1000 watts in the secondary ( $P_s$ ).

$$P_p = P_s = 1000 \text{ watts}$$

$$\text{Also } P_s = E_s \times I_s \quad \text{or}$$

$$1000 = 10 \times I_s \quad \text{or}$$

$$I_s = \frac{1000}{10} = 100 \text{ amperes}$$

In summary then, remember these relationships about transformers;

$$P_p = P_s \text{ (approximately)}$$

Therefore:  $E_p \times I_p = E_s \times I_s$

$$\frac{E_p}{N_p} = \frac{E_s}{N_s}$$

### Use of Laminations

The magnetizing and demagnetizing that occur in transformers, motors and generators cause stray currents, called eddy current, to flow through the magnet itself. The power that is used by this current flow ( $I^2 \times R$ ) comes from the power supply and is a loss.

In order to reduce these losses to a minimum the cores for electric motor and generators and for transformers are not made of solid iron. Instead they are made of thin, soft iron plates (laminations), stacked together and insulated from each other, usually by insulating varnish (See Figure 57). The laminated construction reduces the flow of the eddy currents.

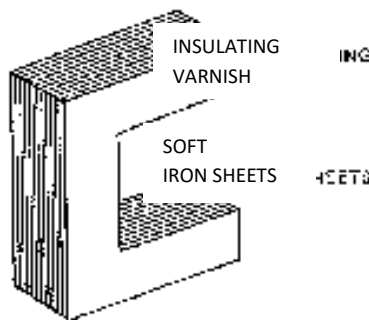

Figure 57

---

## ELECTRICAL SAFETY

Electricity can be dangerous if not properly controlled.

If electrical machinery is used near flammable materials, vapors or gases, sparks may be given off and cause a fire.

If the current flowing through a conductor is greater than the conductor can carry safely, the conductor may overheat and cause a fire or otherwise damage the machines.

If just 1/10 of an ampere passes through your body, the shock could kill you.

Federal safety regulations require that steps be taken to prevent such accidents. Basic requirements are as follows:

Electrical machinery that is used in mines, and other areas where flammable dust, gas, or vapors that may be present, must be enclosed. This will prevent sparks, such as those that occur on motor commutators, switches, and at loose connections, from igniting the flammable materials.

Every electrical circuit must use conductors that are large enough to carry the normal current flow of the circuit, plus an acceptable overload without overheating. For most circuits a 25% overload is allowed. The circuit must also have a fuse or circuit breaker (automatic switch) that will interrupt the current flow if the normal load plus the overload is exceeded.

## **OVER CURRENT PROTECTION**

Electrical equipment and conductors can only carry a limited amount of current without being damaged. Fuses or circuit breakers prevent too much current from flowing through the conductors or through the equipment.

### **FUSE**

A fuse is a piece of metal that is placed in the circuit in series with the load. When too many amperes flow through the fuse the heat generated ( $I^2 \times R$ ) causes the metal to melt and breaks the circuit. A new fuse must be installed to restore power.

### **CIRCUIT BREAKER**

A circuit breaker is a magnetic switch that is also placed in the circuit, in series with the load. When too much current flows through the conductors, the magnetic switch opens and stops the flow. The circuit breaker may then be reset that is, the switch closed and the circuit re-energized.

Conductors supplying power to a mine or other facility are protected by circuit breakers or fuses, before they enter the mine. In addition, a very large fuse or circuit breaker (lightning arrester) is installed to break the circuit if lightning strikes the power lines. A ground wire is also provided to lead the lightning to the ground.

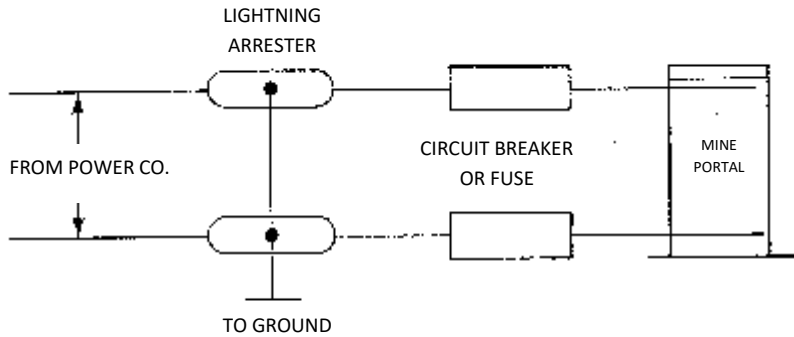

Figure 58

## ELECTROLYSIS

When an electric current flows through a mixture of water dissolved metallic compounds, that is, iron oxide (rust), corroded metal, clay, etc., chemical changes take place. Oxygen and Hydrogen may be generated, and metals with which the current comes in contact may be eroded away and deposited elsewhere. This action can severely damage metal structures that are in contact with the moist material. Good grounding of all equipment can help keep the voltage difference between the structures to a minimum and reduce the possibility of damage. (See Figure 59)

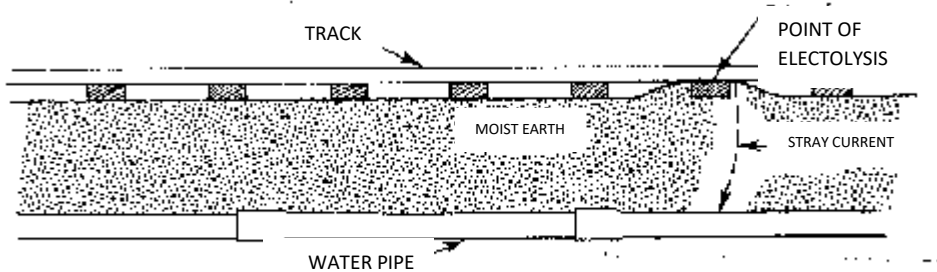

Figure 59

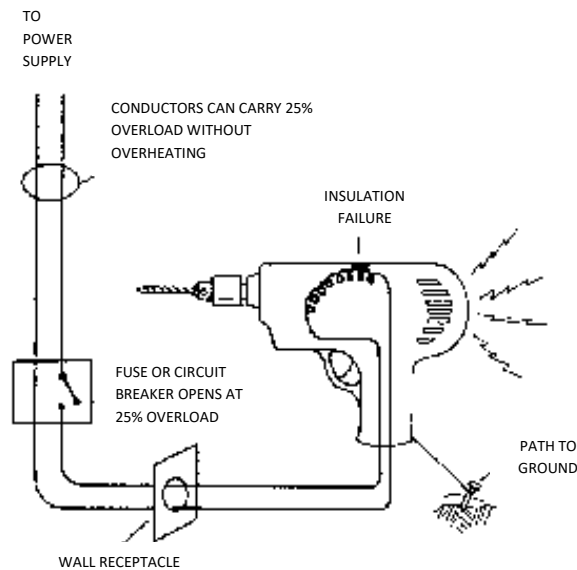

Figure 60

Conductors and other current-carrying parts of the machines shall be insulated or enclosed to prevent persons from touching them. In addition, some areas restrict the maximum voltage permitted on exposed conductors such as trolley wires. Illinois restricts the voltage to 275 volts.

Exposed metal parts of electrical machinery that do not carry current normally, the frames, stands, enclosures, must be connected to the ground. Normally, the conductors and parts of electrical machines through which the current flows are insulated from the frames and other structural parts of the machines. If the insulation is damaged these parts may carry current. If a person touches one of the current carrying parts, his/her body will provide a path for the current to flow to the ground. The person will receive a shock and may be killed. The ground connection provides a path for current to flow to the ground. Thus, if a break occurs in the insulation, current will flow to the ground in sufficient quantity to open the over current protection device.

### DE-ENERGIZING EQUIPMENT

Prior to having personnel work on electrical equipment, the power shall be cut off from that equipment and measures taken to prevent its being turned back on until the work is completed. A typical measure is to lock the switch box closed, hand a sign on the box stating, DO NOT CLOSE SWITCH, and give the key to the person working on the equipment.

# MINE HOIST OPERATOR TRAINING SYSTEM

## UNIT

# INSPECTION



## OBJECTIVE

The trainee will know the requirements and STATE regulations for inspection requirements.

## TIME

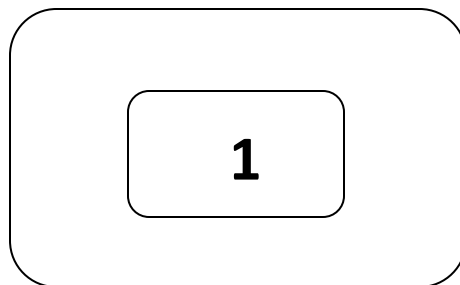



## **INSTRUCTIONAL OBJECTIVES FOR INSPECTION**

The trainee will be able to state, in one or two sentences, the function (use) of inspection.

The trainee will be able to write the requirements for proper hoist inspection.

The trainee will be able to answer, in writing, multiple-choice questions concerning the application of State regulations for inspection.

## INSPECTION

Periodic inspections of the hoist, shaft and related parts are made to assure that operations can be conducted safely. This unit outlines basic inspection requirements. You will learn detailed requirements from your mines rules and regulations.

The hoist operator must know:

1. Hoist parts that require inspection;
2. How often these parts require inspection;
3. Conditions which indicate maintenance or attention is required;
4. Method of recording information in log.

A typical inspection schedule may be:

### **At the beginning of each shift**

The hoist operator examines the hoist and tests over-travel, over-speed, dead-man controls, position indicators, and braking mechanisms. This includes:

- Visually checking:
  - Wiring for loose connections, damaged insulation
  - Hoist housing, structure and drum for loose bolts, cracks and similar defects.
  - Brake mechanism for loose/worn shoes, mechanical defects and hydraulic pressure
  - Safety cable for lubrication, broken wires, deformation.
  - Conveyance for loose, missing or broken parts
  - Safety dogs
- Operating hoist full length of the shaft to make sure that:
  - Shaft is clear and will accommodate skip/cage
  - Appearance and sound of running hoist is normal
  - Wire rope has no apparent defects
  - Depth indicator, ammeter, rope speed meter and others are functioning properly
  - Brakes, clutches and other components are normal
- Testing the following:
  - Communication systems
  - Over-speed controls
  - Over-wing controls
  - Slack rope cut-off

Daily – Visually Examine

- Rope and conveyance—connections to conveyances and drum should be checked.
- The hoist operator should look for abnormalities in the rope, including:
  - Reductions in rope diameter
  - Stretching of the rope
  - Worn, broken or corroded wires
  - Indications of mechanical abuse
  - Abrasions
- Safety catches
- Sheaves
- Shaft (coal)

# MINE HOIST OPERATOR TRAINING SYSTEM

## UNIT

# MAINTENANCE

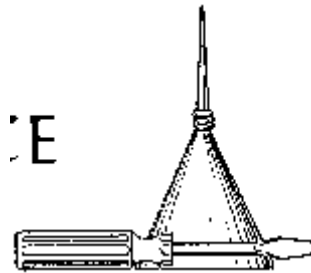

## OBJECTIVE

The trainee will know the requirements and STATE regulations for maintenance.

## TIME

1/2

## **INSTRUCTIONAL OBJECTIVES FOR MAINTENANCE**

The trainee will be able to state in one or two sentences the function (use) of maintenance.

The trainee will be able to answer multiple-choice questions concerning:

1. Work included in maintenance
2. Two kinds of maintenance
3. Sources of maintenance instructions

The trainee will be able to answer, in writing, multiple-choice questions concerning the application of state regulations for maintenance.

## **MAINTENANCE**

Maintenance is the work that is done to keep the mine hoist and its parts repaired and in safe operating condition.

Maintenance includes:

- Housekeeping
- Inspection
- Lubrication
- Repairs
- Replacement of parts
- Adjustments

There are two kinds of maintenance:

1. Corrective Maintenance, which is repairing or replacing parts that have broken down.
2. Preventative Maintenance, which is repairing, adjusting, or replacing parts before they break down.

This work may be the responsibility of the hoist operator or the maintenance personnel. In either case the hoist operator must have a systematic procedure and adequate records to assure that the required work is done according to regulations.

Maintenance instructions come from several sources:

- Federal, State or local regulations.
- Maintenance manuals put out by the manufacturers of the hoist, hydraulic systems and other systems.
- Maintenance procedures put out by the mine foreman, maintenance foreman and other mine managers.

The hoist operator should know the maintenance procedures required to be performed, and the person is responsible for each:

- Pre-shift
- Post-shift
- Daily
- Weekly
- Monthly
- Annually

and the person responsible for doing each.

He/she should have a record of when each task was performed and who performed it.

A check-off list with the above information is a must for a good maintenance program.

## **STATE REGULATIONS**

### **METAL AND NONMETALLIC MINES**

Hoist-men shall be informed when men are working in a compartment affected by that hoisting operation and a "Men Working in Shaft" sign shall be posted at the hoist.

When men are working in a shaft "Men Working in Shaft" signs shall be posted at all devices controlling hoisting operations that may endanger such men.

# MINE HOIST OPERATOR TRAINING SYSTEM

## UNIT

### BEGINNING OF SHIFT ACTIVITIES

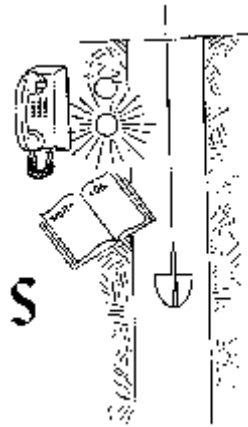

## OBJECTIVE

The trainee will be able to assure that the hoist is in proper operating condition.

## TIME

**1**

## **TRAINING OBJECTIVES FOR BEGINNING OF THE SHIFT ACTIVITIES**

The trainee will be able to explain, in writing, each of the five tasks the hoist operator performs at the beginning of the shift.

Given a list of mine hoist parts and a list of possible defects, the trainee will be able to match each part to its possible defects

The trainee will be able to answer multiple-choice questions about the procedure for grease lubrication.

Given an illustration of an oil flow or reservoir system, the trainee will be able to write procedures for lubricating with each system.

The trainee will be able to answer multiple-choice questions about:

1. Operating conveyance the full length of the shaft
2. Logging

Given an illustration of the control panel, the trainee will be able to write the procedure for testing power to the hoist.

Given an illustration of each of the safety devices, the trainee will be able to write the procedures for testing the operation of that device.

At the beginning of a shift, the hoist operator has Five basic tasks to perform to assure that the hoist is ready to operate:

1. Check the general condition of the hoist
2. Check the hoist parts for proper lubrication
3. Check the power supply to the hoist
4. Operate the hoist the full length of travel
5. Check the operation of the safety devices

The first task the hoist operator does is to find out the general condition of the hoist. To do this he/she will:

- Find out what happened on the previous shift:
  - Read log
  - Talk to previous operator

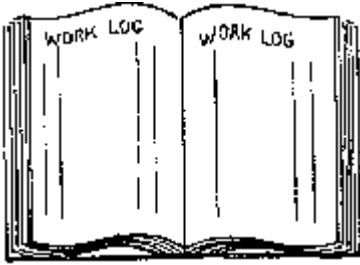

- Visually inspect for defects such as:
  - Hoist anchorage, structure and drum: loose bolts and nuts, structural cracks
  - Brakes: abnormal hydraulic or pneumatic pressure, loose shoes or worn bands
  - Wiring: frayed, insulation, loose connection
  - Hoist Rope: loose couplings on conveyance and safety cables, no slack in safety cable, needs lubrication.

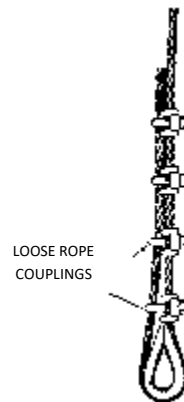
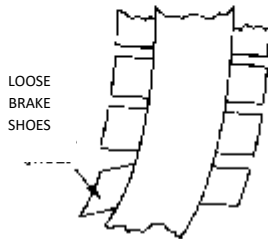
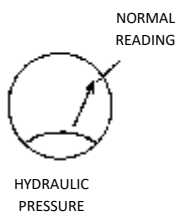
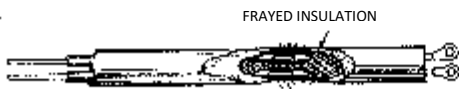
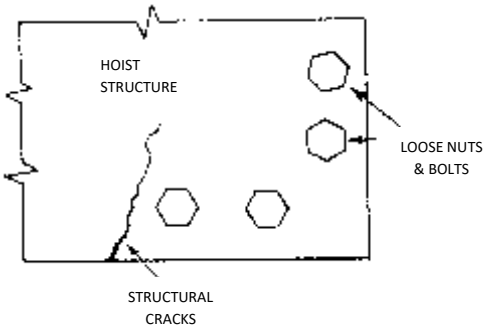



The next task a hoist operator does when he/she comes on shift is to assure the lubrication is provided to the points that require it.

In I-A-13 various lubrication systems were described. Here is how the hoist operator will use them to assure that the hoist is properly lubricated.

For installed grease systems, he/she will:

- Inspect grease supply in reservoir.

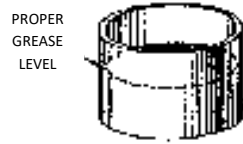

- Test the system operation.



- Inspect for grease at the lubrication points.
- Request assistance if necessary.

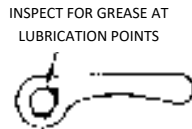

Record activities in the log.

With a portable grease gun, the hoist operator will:

- Inspect for grease at points to be lubricated.
- Lubricate where necessary.

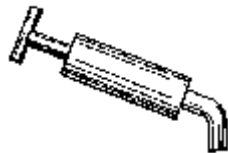

For a hoist with an oil flow system he/she will:

- Inspect oil supply in reservoir
- Inspect pump (look at pressure gauge)
- Inspect for leaks
- Inspect sight glass for normal oil flow
- Request assistance if necessary

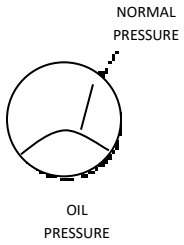
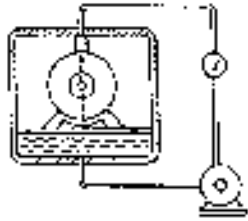

Record activities in the log.

For hoists with an oil reservoir system he/she will:

- Inspect oil supply in reservoir
- Inspect bearings for leaks
- Request assistance if necessary

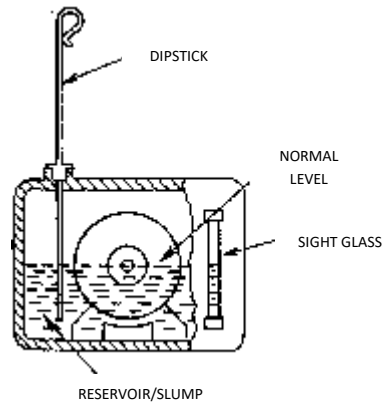
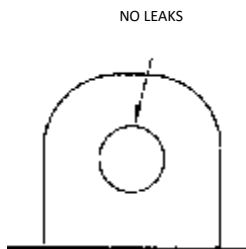

Record activities in the log.

The third task the hoist operator performs is to assure that the power is available to all parts of the hoist. The power is controlled by switches. If the switch is **CLOSED**, power flows through the switch and is **ON**. If the switch is **OPEN**, power cannot flow through the switch and is **OFF**.

To assure that power is available to the switchboard the hoist operator will:

- Close the main power switch on the switchboard (turn power **ON**.)
- Note if the indicator light is **ON**.

To assure that power is available to the hoist control stand:

- Close the power switch on the control stand (turn power **ON**.)
- Move the motor control in one direction.
  - Note the deflection ammeter.
- Move the motor control in the other direction.
  - Note deflection of ammeter.
- Request assistance if test fails.

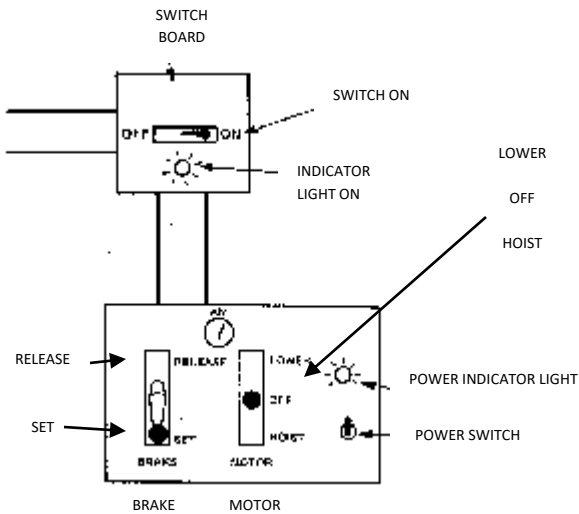

Record activities in the log.

The next task the hoist operator does is to run an empty conveyance at slow speed the full length of the shaft. This is done to assure that the shaft is clear and that the controls operate properly. Often an inspector rides in the skip or cage and he/she looks for abnormalities in the shaft. The specific procedure for operating the hoist is in the unit "Routine Shift Activities."

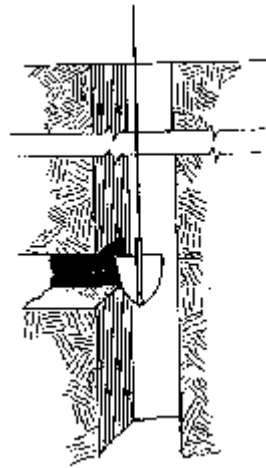

Another task to be performed at the beginning of the shift is to test the hoist safety devices. If a device fails its test, it must be repaired before starting operations. The results of these tests must be recorded in the log. These tests may be performed by the hoist operator or by maintenance personnel.

### **Over-speed Cutout Switch**

The over-speed cutout switch is built into the Lilly, Simplex or other safety controller. To test the functioning of this device:

- Set the brake and stop the hoist
- Manually raise the weights on the governor
- Check to see that the main power switch opens (power turns OFF)
- Close the main power switch if it opens satisfactorily, otherwise have it repaired.

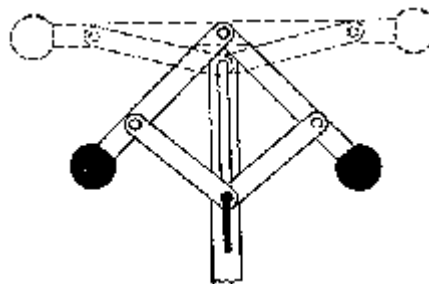

## Over-travel Cutout Switches

There are two cutout or limit switches to prevent over travel, one at each end of the shaft. The switch near the top prevents the conveyance from traveling too far below the deepest landing.

To test the cutouts, the hoist operator will:

- Move the conveyance slowly above/below the collar/deepest landing. The main power switch should open and the brakes should be set as the conveyance crosses the cutout level.

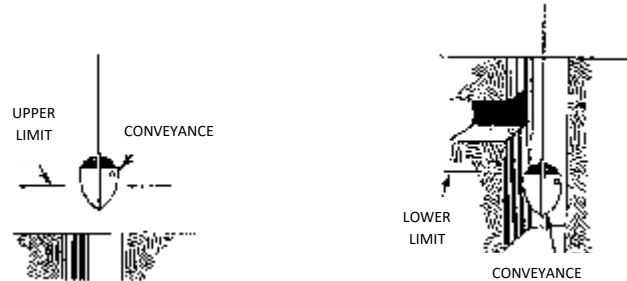

If the main power switch opens, the hoist operator will:

- Set the brake and put the motor control on **OFF**
- Close the over-travel bypass switch
- Return the conveyance to the normal operating area

If the main power switch does not open, the hoist operator will:

- Set the brake
- Put the motor control on OFF
- Request assistance
- 

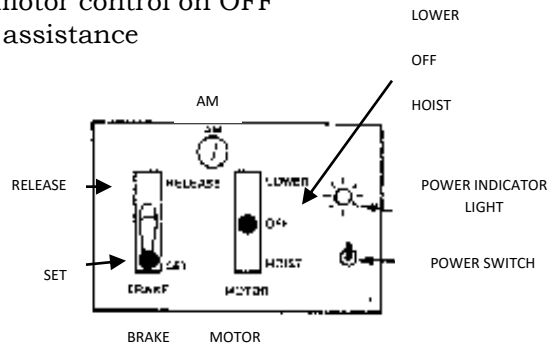

On some hoists, the safety controller also has an over-travel cutout switch. On such hoists the safety controller must be bypassed in order to test the shaft over-travel switches.

## **Slack Rope Switch and Conveyance Safety Dogs**

The slack rope switch will cut off power to the hoist and apply the drum brakes if the rope goes slack. To test the switch the hoist operator will:

- Support the conveyance. The support may be wood/metal beams or chains.
- Slack the hoist rope.

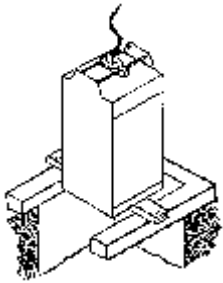

As the rope goes slack:

- The main power switch should open.
- The safety dogs should begin to clamp on the shaft guide.

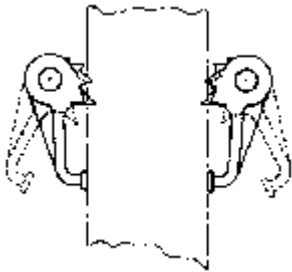

If the test is successful:

- Set the brake
- Put motor control on OFF
- Close slack rope bypass switch
- Raise conveyance slowly until it is lifted off the supports if beams were used
- Remove the supports

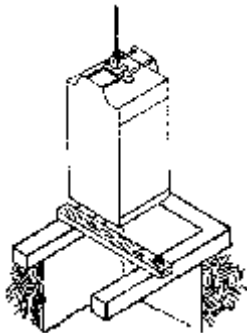

If the test fails, request assistance.

## **Deadman Switch**

Most hoists are equipped with a “deadman switch.” The switch is normally open and cuts off power to the hoist. The purpose of the switch is to remove power from the hoist and apply the brakes if something should happen to the hoist operator (has heart attack, drops dead, or becomes ill). The switch may be located on the floor or on the side of the hoist control stand. The operator closes the switch by standing on it or by pressing his/her knee or leg against it.

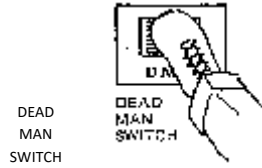

To test the deadman switch, the operator tries to apply power to the hoist with the switch open (he/she is not standing on it or pressing against it). If power is applied, the switch is not working properly and must be repaired.

Each hoist is different. The above safety devices are required by law but there may be additional safety devices in your mine. You must learn what they are and how to test them. This will be done in Parts II and III.

### **Logging**

STATE regulations require that complete records be kept of installation, lubrication, inspection, tests and maintenance of shafts and hoisting equipment. Your mine will have specific rules for making log entries in agreement with these regulations.

In Parts II and III you will learn what entries to make in the log and the format for making each.

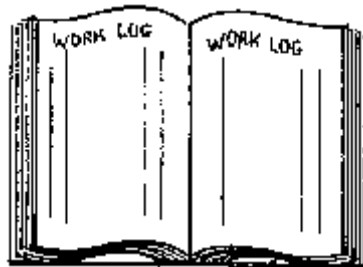

(225 ILCS 705/Art. 16 heading)

ARTICLE 16.  
CAGES.

(225 ILCS 705/16.01) (from Ch. 96 1/2, par. 1601)

Sec. 16.01. A cage used for hoisting men must be of substantial and safe construction; have adequate steel bonnets to protect men riding on the cage; have enclosed sides; have gates, safety chains, or bars across the ends of the cage when men are being hoisted or lowered; and have sufficient handholds or chains for all men on the cage to maintain their balance. Such cage shall be fitted to guides running from the top to the bottom.

(Source: Laws 1953, p. 701.)

(225 ILCS 705/16.02) (from Ch. 96 1/2, par. 1602)

Sec. 16.02. The floor of the cage shall be constructed so that it will be adequate to carry the load and so that it will be impossible for a worker's foot or body to enter any opening in the bottom of the cage.

(Source: P.A. 81-992.)

(225 ILCS 705/16.03) (from Ch. 96 1/2, par. 1603)

Sec. 16.03. Cages and cars used for handling men in shafts and slopes shall be equipped with safety catches which act quickly and efficiently in an emergency.

(Source: Laws 1953, p. 701.)

(225 ILCS 705/16.04) (from Ch. 96 1/2, par. 1604)

Sec. 16.04. Cages shall be inspected daily.

(Source: Laws 1953, p. 701.)

(225 ILCS 705/16.05) (from Ch. 96 1/2, par. 1605)

Sec. 16.05. Self-dumping cages shall be securely locked when men and materials are being handled.

(Source: Laws 1953, p. 701.)

(225 ILCS 705/16.06) (from Ch. 96 1/2, par. 1606)

Sec. 16.06. The cage on which men are riding shall not be lifted or lowered at a rate of speed greater than 600 feet per minute, except by written consent of the State Mine Inspector.

(Source: Laws 1953, p. 701.)

(225 ILCS 705/16.07) (from Ch. 96 1/2, par. 1607)

Sec. 16.07. No person shall carry any tools, timber or other materials with him on any cage that is in motion, except for the purpose of repairing the shaft.

(Source: Laws 1953, p. 701.)

(225 ILCS 705/16.08) (from Ch. 96 1/2, par. 1608)

Sec. 16.08. No one shall ride on a cage containing either a loaded or empty mine car.

(Source: Laws 1953, p. 701.)

(225 ILCS 705/16.09) (from Ch. 96 1/2, par. 1609)

Sec. 16.09. No coal or other materials shall be on the cage while the cage is being used for hoisting or lowering men into or out of the mine.

(Source: Laws 1953, p. 701.)

(225 ILCS 705/16.10) (from Ch. 96 1/2, par. 1610)

Sec. 16.10. When workers have finished their day's work, or have been prevented from further work, and come to the bottom to be hoisted out an empty cage shall be given to them for that purpose, unless there is an available exit by slope or stairway and if there is no coal at the bottom waiting to be hoisted. In case of an injury, or bona fide



illness, the man shall be given a cage at once.  
(Source: P.A. 81-992.)

(225 ILCS 705/16.11) (from Ch. 96 1/2, par. 1611)

Sec. 16.11. Socketed ropes shall be cut off and resocketed pursuant to the manufacturer's recommendation, if found to be damaged or defective, and a notice shall be posted in the engine room giving the date when the rope was installed and when resocketed.

(Source: P.A. 99-538, eff. 1-1-17.)

(225 ILCS 705/16.12) (from Ch. 96 1/2, par. 1612)

Sec. 16.12. Hoisting ropes attached to all cages or trips shall be adequate in size to handle the load and have a proper factor of safety as defined in the American Standards Association's Wire Rope Standards and shall be replaced when it shows more than six broken wires in any single pitch length or lay of rope.

(Source: Laws 1953, p. 701.)

(225 ILCS 705/Art. 26 heading)

ARTICLE 26.  
SHAFTS.

(225 ILCS 705/26.01) (from Ch. 96 1/2, par. 2601)

Sec. 26.01. Any shaft or other opening in process of sinking, or driving, for the purpose of mining coal, shall be subject to the inspection of the State Mine Inspector for the district in which said shaft or opening is located.

(Source: Laws 1953, p. 701.)

(225 ILCS 705/26.02) (from Ch. 96 1/2, par. 2602)

Sec. 26.02. Over every shaft that is being sunk or shall hereafter be sunk, there shall be a safe and substantial structure to support sheaves or pulley ropes at a height not less than 15 feet above the tipping place. The landing platform of such shaft shall be so arranged that material cannot fall into the shaft while the bucket is being emptied or taken from the hoisting rope. If provisions are made to land a bucket on a truck, said truck and platform shall be so arranged that material cannot fall into the shaft.

(Source: Laws 1953, p. 701.)

(225 ILCS 705/26.03) (from Ch. 96 1/2, par. 2603)

Sec. 26.03. When men are in the bottom of the shaft, rock or coal shall not be hoisted except in a bucket or on a cage and said bucket or cage must be connected to the hoisting rope by a safety hook, clevis or other safety attachment. The rope shall be fastened to the side of the drum and not less than three coils of rope shall remain on the drum. In shafts over 100 feet in depth, suitable provision shall be made to prevent the bucket from swinging while being lowered or hoisted, and guides provided for this purpose shall be maintained at a distance of not more than 75 feet from the bottom of the shaft.

(Source: Laws 1953, p. 701.)

(225 ILCS 705/26.04) (from Ch. 96 1/2, par. 2604)

Sec. 26.04. An efficient brake shall be attached to the drum of the engine used for hoisting in shaft sinking, and the drum shall be provided with a flange on each end not less than 4 inches in height.

(Source: Laws 1953, p. 701.)

(225 ILCS 705/26.05) (from Ch. 96 1/2, par. 2605)

Sec. 26.05. Not more than 4 persons shall be lowered or hoisted in or on a bucket in a shaft at one time, and no person shall ride on a loaded bucket.

(Source: Laws 1953, p. 701.)

(225 ILCS 705/26.06) (from Ch. 96 1/2, par. 2606)

Sec. 26.06. All blasts in shaft sinking shall be exploded by electric battery.  
(Source: Laws 1953, p. 701.)

(225 ILCS 705/26.07) (from Ch. 96 1/2, par. 2607)

Sec. 26.07. Provisions shall also be made for the proper ventilation of shafts while being sunk.  
(Source: Laws 1953, p. 701.)

(225 ILCS 705/26.08) (from Ch. 96 1/2, par. 2608)

Sec. 26.08. No one but a certified hoisting engineer shall be in charge of the hoisting engine while a shaft is being sunk.  
(Source: Laws 1953, p. 701.)

(225 ILCS 705/26.09) (from Ch. 96 1/2, par. 2609)

Sec. 26.09. The upper and lower landing at the top of each shaft, and the opening of each intermediate seam from or to the shaft, shall be kept clear and free from loose materials, and shall be protected with automatic or other gates, such gates to be of good, serviceable construction for the purpose for which they are designed, namely, to prevent either men, or materials from falling into the shaft. At the top, landing cage supports, where necessary, must be carefully set and adjusted so as to securely hold the cage when at rest.  
(Source: Laws 1953, p. 701.)

(225 ILCS 705/26.10) (from Ch. 96 1/2, par. 2610)

Sec. 26.10. Every vertical shaft in which men are hoisted and lowered must be equipped with a cage, or cages, fitted to properly constructed guides running from the top to the bottom.  
(Source: Laws 1953, p. 701.)

(225 ILCS 705/26.11) (from Ch. 96 1/2, par. 2611)

Sec. 26.11. At every underground landing where men enter or leave the cage and where men must pass from one side of the cage to the other there shall be a safe passageway, free from obstruction and dry as possible around the shaft, not less than 3 feet wide for the use of men only; and animals or cars shall not be taken through such passageway while men are passing or desirous of passing through such passageway.  
(Source: Laws 1953, p. 701.)

(225 ILCS 705/26.12) (from Ch. 96 1/2, par. 2612)

Sec. 26.12. No accumulation of ice or obstructions of any kind shall be permitted in any shaft in which men are hoisted or lowered; nor shall any dangerous gases or steam be discharged into the shaft in such quantities or at such times as to interfere with the safe passage of men. All surface or other water which flows therein shall be conducted by rings or otherwise to receptacles provided for the same in such manner as to prevent water from falling upon men while passing into or out of the mine or while in the discharge of their duties about the shaft bottom.  
(Source: Laws 1953, p. 701.)

(225 ILCS 705/26.13) (from Ch. 96 1/2, par. 2613)

Sec. 26.13. All hoisting shafts, air shafts, and escapement shafts constructed after March 1910, shall be of fireproof construction, and if poured concrete is used in said construction it shall be not less than 6 inches in thickness. Cage guides and buntons may, however, be constructed of wood. Drifts and slopes must be fireproof for a distance of 300 feet from the entrance.  
(Source: Laws 1955, p. 2012.)

(225 ILCS 705/26.14) (from Ch. 96 1/2, par. 2614)

Sec. 26.14. The roof and walls of the passageway leading from the bottom of the hoisting shaft and the air and escapement shaft designated as such under the law, within

a distance of 300 feet from the bottom of either of said shafts, shall be of fireproof construction, except that the coal rib or pillar may be used as a wall in such passageways.

(Source: Laws 1953, p. 701.)

(225 ILCS 705/26.15) (from Ch. 96 1/2, par. 2615)

Sec. 26.15. Shafts shall be equipped with self-closing or manually controlled safety gates at surface landings.

(Source: Laws 1953, p. 701.)

(225 ILCS 705/26.16) (from Ch. 96 1/2, par. 2616)

Sec. 26.16. Positive derails shall be placed on tracks leading to shafts to prevent cars, motors, etc. from going into the shaft when the cage is not at the landing. The provisions of this section shall not apply to "slope" or "drift" mines, unless definite danger is imminent.

(Source: Laws 1957, p. 2413.)

## ELECTRICAL HOISTING ENGINEER

Your decision to become a Hoisting Engineer is a very important step that you are taking. After you have received your Hoisting Engineer Certificate, you may legally hold a job as Hoisting Engineer at any coal mine in Illinois. The job of Hoisting Engineer has a very large amount of responsibility with it, in fact you have the lives of every underground employee in your hands, and this fact should be thoroughly understood and appreciated by you at all times.

### LESSON NO. 1

1. Q. What are the laws in Illinois in reference to persons seeking Certificates as EHE?
  - A. He must be a citizen of the U.S.A. or lawfully admitted for permanent residence. He must be at least 21 years of age and had at least 2 years of experience with electrical equipment and pass an examination satisfactory to the State Mining Board.
2. Q. What is the law in regard to the operation of cages?
  - A. Every hoist engine shall be at all times equipped with a good brake, drum must have flanges on the side of the drum, not less than 4" above the rope when the rope is all on the drum; there must be at least 3 laps of rope left on the drum, when the cage or car is at the bottom. The rope to be securely fastened to the drum, also there must be an index dial or indicator that truly shows the position of the cages or cars at all times.
3. Q. What is the code of signals used in Illinois?
  - A. The code of signals used is as follows: From the bottom to the top, one ring signifies hoist coal of the empty cage, or also to stop either when in motion. Two rings or whistles shall signify to lower cage. Three rings or whistles shall signify that men are ready to come up or go down. When the proper signal (one bell or whistle) is given by the engineer, the men shall get on the car, then the cages will give the proper signal to hoist or lower, as a case may be. Four rings mean to hoist slowly, meaning some dangerous condition. Five rings shall mean a call for a stretcher, implying an accident in the mine. Six rings shall mean to hold cage perfectly still until signaled otherwise. From top to bottom 1 ring or whistle means: All ready; get on cage. Two rings or whistles mean send away the empty cage.
4. Q. What is the law in regard to the speed of cages when hoisting or lowering men?
  - A. When hoisting or lowering men the speed of the cage shall not be over 600ft. per minute.
5. Q. What are the duties of an EHE?
  - A. The engineer must be in constant attendance at the hoist when any men are underground. He shall not allow any person to meddle with any part of the equipment, he shall at all times keep his mind of his business and talk to no one while he is busy with the hoist or signals. He shall keep a careful look-out over all the machinery and give proper care of same.
6. Q. What experience have you had in operating an electric hoist?
  - A. Give a brief outline of all your experience with mining machinery.

7. Q. What makes you think that you would be a good EHE?  
A. Give your reasons in a few straight-forward words.
8. Q. If something went wrong while you were hoisting a cage of men, what would you do?  
A. I would stop the cage and securely set the brake, until the trouble was found out and was ready to be hoisted. I would start the hoist very slow.
9. Q. Name and define the 4 electrical units.  
A. The 4 electrical unites are as follows: 1. Volt – the unit pressure. 2. Watt – The unit of power. 3. Ampere – The unit of volume. 4. Ohm – The unit of resistance.
10. Q. What is the Ohm's Law?  
A. The current which flows in the circuit is equal to the pressure divided by the resistance of the circuit. This relation between the electrical current, pressure, and resistance is known as the Ohm's Law.

## LESSON NO. 2

1. Q. Why are fly-wheels used on a Hoisting Engine?  
A. Fly-wheels are used to supply energy for accelerating the hoist, thus reducing the peak load of power taken from the high-tension lines. In other words, a fly-wheel is used to help carry the load over the peak without using more power off the power line.
2. Q. What is a transformer?  
A. A transformer is a device for changing alternation current from one voltage to another voltage.
3. Q. What is a rotary converter?  
A. A rotary converter is a device or a machine for changing A.C. to D.C.
4. Q. (a) What care should be given A.C. Motors? (b) What is a motor generator set?  
A. (a) They should be thoroughly blown out at proper intervals, no oil or grease to be allowed into the windings, bearings to be properly oiled, and the air gap to be carefully watched. (b) A motor generator set consists of a motor and generator, directly connected together, mounted on the same base. The set may be an A.C. Generator. There are both types or kinds.
5. Q. What is an auxiliary motor, as is sometimes used in connection with a flywheel type Hoist? Why are auxiliary motors used?  
A. An auxiliary motor is an A.C. motor so arranged as to drive the drums, through gears, when the D.C. motor is not in use. They are used to do the hoisting at night or idle days, when the hoist is being used as little, thus saving power by letting the fly wheel set be idle. The auxiliary motor uses no power when not in use.
6. Q. What care should be given a D.C. motor or a D.C. generator?  
A. They should be blown out thoroughly at frequent intervals. The winding and commutators should be kept free from dirt, oil or grease; the mica should be kept slightly lower than the commutator bars, the brushes should be free in the holders

and have the same spring pressure, oil should be changed regularly, and the air gap kept as even as possible.

7. Q. What type drum is commonly used on electric hoists? Why?
  - A. Cylinder-Conical which consists of a cylinder of small diameter, a conical part and a cylinder of large diameter. This type of drum is used to take better advantage of the empty car and cage, when accelerating the load. While the rope to the empty cage is unwinding from the large diameter of the drum while load is being reeled on the smaller diameter of the drum, thus giving the empty cage a large advantage over the loaded cage, when the drum is properly proportioned.
8. Q. What is electricity?
  - A. Electricity is either a substance or a force. It is not exactly or thoroughly understood just what electricity is. Some scientists believe it to be the same as the other, other think it is a force or form of energy, other think it is a condition of the ether, while others believe that it is the fundament or foundation of which all the elements are modifications.
9. Q. What is a circuit breaker?
  - A. A circuit breaker is an electro-magnetic device for opening an electric circuit when the current varies beyond certain desired limits. They are used to break the circuit when the current goes too high also, they are used to break the circuit, if it falls too low. It is operated by an electro-magnet whose core is attracted so as to trip a release trigger or detent and allow a spring to throw open the switch when the current exceeds the limit set. Circuit breakers are sometimes used instead of or to supplement fuses with dynamos and motors.
10. Q. What is a fuse? What is a fuse block?
  - A. There are two kinds of fuses mentioned in electrical matters. One kind of fuse being used to fire explosives, by being heated, and the one which melts and breaks the electric current, this latter fuse being the one referred to in this question. It is made of a metal that has a lower melting temperature than the electrical wiring, etc. It is made in certain sizes to carry certain loads before melting and therefore breaks the current. A fuse block is for holding the fuse. It generally consists of brosa clamps, generally mounted on a porcelain base; also, nearly always equipped with a cover, both to prevent the metal from flying when it "blows" or melts, also as a protection from the weather, safety, etc.

### LESSON NO. 3

1. Q. What is known as a conductor, also as a non-conductor, in connection with electricity?
  - A. There are no known perfect conductors.
2. Q. Name some good conductors. Name some good non- conductors.

- A. Some near good conductors, are copper, silver and most of the other metals. Some near good non-conductors are the following: Glass, rubbery, clay products, etc.
3. Q. What is a kilowatt hour?
- A. The kilowatt hour is the unit commonly used in measuring electrical energy. It is the energy or work done by 1 K.W. operating for 1 hour. For example, 50 K.W. hours might mean 50 K.W. for 1 hour, or 1 K.W. for 50 hours, or 200 K.W. for  $\frac{1}{4}$  hour.
4. Q. What is a circular Mil?
- A. The circular mil is the unit used in measuring the area of electrical conductors. A circular mil is the area of a circle that is 1 Mil in diameter. 1 mil equals  $\frac{1}{1000}$  of an inch. In other words, a circular mil would be equal to the area of a round wire that is  $\frac{1}{1000}$  of an inch in diameter.
5. Q. What is a Rheostat?
- A. A Rheostat is a device or conductor so made that it dissipates electric energy into heat. It may be used simply to regulate the resistance of the circuit. It is used to develop the desirable heat from electricity. Usually, the Rheostat is so arranged that its resistance may be changed at will.
6. Q. What do you think best, safety catches operated by springs or by weights? Why?
- A. Safety catches operated by a spring are more reliable than those actuated by weights for the reason that they act quicker therefore are nearer positive acting. The weight has to fall to actuate the catches, while at the same time, the cage would be falling, thereby losing time in which the catches could take hold.
7. Q. What is meant by a magnetic field?
- A. By Magnetic Field is meant the electrical force around and near a magnet. This will be shown if a compass needle is moved about a magnet, showing there is a field of force all around the magnet.
8. Q. What is a man-speed Switch?
- A. A man speed switch is so arranged that when it is closed the hoist cannot be operated at a higher rate of speed than is prescribed for the hoisting or lowering men.
9. Q. How is electricity generated in a dynamo?
- A. The exact action is not entirely understood, although it is known that we can construct machines with accurate and positive knowledge of results. The fundamental principles are that an electro motive force is induced by every change in the number of lines of magnetic force enclosed by a circuit and that an electric current is surrounded by a magnetic field.
10. Q. What special precautions must be taken when changing or taking up ropes on a cylinder conical drum?
- A. The proper number of active turns of the rope on the small diameter of the drum must be maintained at all times. If this is not done the driving motor will not be properly loaded, and the cams and geared limit switches will be put out of adjustment. The load on the hoist motor will also be out of adjustment.

## LESSON NO.4

1. Q. How can magnetic leakage be detected and measured?
  - A. If a compass needle is brought near a magnet, the needle will begin to vibrate more or less rapidly, according to the strength of the magnetic field. The rapidity of the vibrations and the large amount of variation of the needle pointing north and south is an indication of the strength of the field. Also, the strength of the leakage field may be indicated by the strength with which the magnet will attract a piece of iron or steel, such as a screwdriver or a wrench, etc. The leakage may be measured by a ballistic galvanometer, or a suitable voltmeter when the magnetizing current is cut off or reversed.
2. Q. What are the fundamental principles upon which the electric motor operates?
  - A. Every current is surrounded by a magnetic field or force which tends to distort or bend any other magnetic field in the vicinity. The two converge into a resultant field whose lines of force tend to become as short as possible, thereby tending to move or change both sources to a new arrangement, such that the lines may be as short as possible. In doing this the result is the "field" which is usually the space between the poles of an electro-magnetic; the current being carried in wires on or near the surface of a cylinder of laminated iron, the combination of wires and iron is what is known as the "armature".
3. Q. What kind of dynamos are separately excited?
  - A. It is common to use a small auxiliary dynamo, called an exciter to furnish current for the field coils of an alternator. In some cases, large continuous current dynamos are separately excited, especially when used on a grounded circuit as for electric railway work.
4. Q. Of what parts is the armature composed?
  - A. The armature is composed of the following wires or coils and the armature "core". This core generally consists of a large number of discs of sheet iron fastened together upon a "spider" or a shaft. Another part is the "commutator" to which the ends of the wires are attached with which the "brushes" make contact to carry the current to the outside circuit. In large dynamos, the iron core does not extend to the shaft, but has the center cut away. In direct-current machines, for high voltage, such as are light dynamos, where it is necessary to have considerable distance between the coils, which surround only one side of the round core of iron. For circuits of different voltages, we have different designs, but all are on one general principle. In all armatures, an important part is the insulation, which must be carefully selected and placed, in order to prevent any electrical connection between the windings and the iron core.
5. Q. How is a Shunt-dynamo started?
  - A. If the machine has been running before and is in good running order, simply let down the brushes so that they press against the commutator and bring the machine up to



- speed. If everything is okay the field magnetism will “pick up” as the machine comes up to speed, and in a short time will be generating full voltage. The voltage may be adjusted up or down by moving the rheostat handle.
6. Q. How can one tell whether the brushes are in the proper position?
    - A. If there is little or no sparking when the machine is working, it is safe to say that the brushes are set properly. On bi-polar machines the brushes should bear upon the commutator at points that are diametrically opposite. In general, the brushes should be so spaced as to divide the commutator into as many equal parts as there are poles in the field magnet. There are several different types of setting brushes on the different types of dynamos and motors. Care should be taken that the springs press the brushes firmly but flexibly against the commutator.
  7. Q. What causes sparking at the brushes?
    - A. Sparking may be caused by either of several things, some of which are there may be a different of potential between the brush and the part of the commutator that is passing from under the brush. Sparking is also caused by broken brushes or broken brush springs, also by the bars on the commutator becoming worn down, lower than the mica between the bars. This mica should always be a little lower than the bars, enough lower that the brushes will not touch the mica.
  8. Q. How can one correct a Dynamo that is reversed?
    - A. Lift the brushes and then close the main switch, so that the current from the main will flow thru the magnet coil and magnetize the field properly; then, move the rheostat to the lowest voltage, so as to reduce the current thru the fields; open the switch slowly, then place the brushes in position and let the machine build up. If current cannot be taken from the main, a few cells of battery will usually supply enough current.
  9. Q. What is a motor-generator set?
    - A. A motor generator set is a transforming device, consisting of a motor, mechanically connected to one or more generators, either motor or generator may be made for direct or for alternation current of any reasonable voltage frequency. Two alternation current machines may be motor-generators or frequency changers.

## LESSON NO. 5

1. Q. Explain the elementary principles of the transformer.
  - A. The fundamental principle of a transformer is practically the same as that of a dynamo, namely an E.M.F. or electro motive force. Is set up by any change in the number of lines of force, enclosed by, or threaded thru, a circuit. The alternating current thru one coil causes the iron core to be demagnetized or re-magnetized in the opposite direction corresponding to every cycle in the magnetizing current. This changing magnetization induces corresponding E.M.F.'s in every coil surrounding the

- iron core. The E.M.F. in each coil being proportional to the rate of change of magnetization and also to the number of turns of wire in the coil. There is thus an induced E.M.F. in the magnetizing coil as well as in the other.
2. Q. What is meant by step-up and step-down transformers?  
A. A step-up transformer is one used for changing the voltage from low to high. A step-down transformer is one used for changing the voltage from high to low. There is no difference between the two except for the use that they each have.
  3. Q. How do alternators differ from direct current generators?  
A. In dynamos or motors using direct current commutators are required for rectifying the current, the need of the adjusting of the brushes requires the armature to be the moving part. The alternator has more field poles and the armature of field may revolve. Ordinarily, current is conducted to and from the motor thru brushes bearing on continuous rings called collective rings or slip rings.
  4. Q. (a) How would you reverse a three-phase induction motor? (b) How would you reverse a shunt-wound d.c. motor?  
A. (a) Reverse any two of the three leads to the starter. (b) Reverse either the shunt field or reverse the armature leads.
  5. Q. In the use of carbon brushes on the generator or motor, what is a "pig-tail" and what does it serve?  
A. A "pig-tail" is a short wire connection between the carbon brush and the commutator ring, which makes unnecessary the passing of the current thru the brush holder and avoids any trouble that might occur from the heat of the brush holder.
  6. Q. Is carbon a good conductor?  
A. Carbon is a poor conductor, compared with the metals.
  7. Q. How is the conversion of A.C. to D.C. accomplished?  
A. By a motor-generator set or a rotary convertor.
  8. Q. What is the use of an automatic circuit breaker?  
A. Commonly used for the protection of the generator against overloads in power stations, light stations and mine use.
  9. Q. Explain the method of calculating the breaking strain and safe working load of hoisting and hauling ropes.  
A. The strength of hoisting and haulage rope varies directly as the square of the diameters. Then for the rule we have, multiply the square of the diameter of the rope in inches by the breaking strain of a one-inch rope, in tons, of the same style of materials, and the result will be the breaking strain in tons. The breaking strain of hoisting and haulage ropes of one inch in diameter, are as follows:  
Cast steel ropes, 34 tons for 1 inch rope.  
Crucible steel ropes, 39 tons for 1 inch rope.  
Plow steel ropes, 44 tons for 1 inch rope.

The safe working load for hoisting ropes is  $1/5$  of the breaking strains.

Example: What is the breaking strain and safe working load of a good steel hoisting rope that is 1.5 inches in diameter? We have  $1.5 \times 1.5$  equals 2.25, then  $2.25 \times 39$  equals 87.75 tons equal breaking strain. Then 87.75 or say 88:5 equal 17.7 or 18 tons equal safe load. NOTE: When we say square a number by itself, as the square of 5 means  $5 \times 5$  equals 25 equal the square of 5.

10. Q. In construction a building 90 feet from the shaft or slope, what parts of this building may be constructed of wood?
- A. Only the floors, doors, windows, or the frame for them. All other parts should be made some non-combustible material such as sheet iron, concrete, or concrete blocks, etc.

## LESSON NO. 6

1. Q. To what use is electricity applied in the operation of a coal mine?

A. Electricity is applied to nearly all machinery used in or around a coal mine, some of which are haulage, pumping, drilling, hoisting, coal cutting, coal loading, running the ventilation fan, lights, signaling, phones, etc.
2. Q. Why is A.C. more dangerous to use than D.C. in and around coal mines?

A. Contact with a live wire carrying alternating current is generally more severe, because of the rapid recurring shocks produced on the nervous system, while on the other hand, a shock from a wire carrying direct current causes a single shock and the current flows steadily and burns the flesh until the contact is broken.
3. Q. Why is the core of an armature always laminated? What is meant by laminated?

A. (a) The reason for the core of the armature to be of laminated material is to prevent what is known as eddy currents, which would cause the armature to heat at those points, or would oppose or destroy the efficiency of the armature. (b) By laminated, or laminations is meant that the core of the armature is not made of one solid piece of metal, but is built up of several different plates or parts, thereby tending to keep down the eddy currents.
4. Q. Explain why copper brushes are sometimes preferred to carbon brushes in mine work?

A. (a) The sparks produced by copper brushes have less intensity or heat than the sparks coming from carbon brushes, thus not being so apt to set off any gas or dust, should either be present. (b) Sparking may be of adjustment, over loaded, weak brush springs, rough commutator, high or low bars, high mica, dirty brushes, commutator, high speed, bad bearings, etc.
5. Q. What is the law of Illinois applying to hoisting signals?

A. 2 rings or whistles signify to lower. 3 rings or whistles signify that men are ready to go down or to come out of the mine. 4 rings or whistles shall mean to hoist slowly. 5 rings or whistles shall signify accident in the mine, send a stretcher down.

6 rings or whistles shall mean to hold the cage still until signaled otherwise. From top to bottom, 1 ring or whistle shall signify all ready, get on cage. 2 rings or whistles shall signify, send away the empty cage.

6. Q. The electric signaling apparatus at a mine is out of order. What may be the cause?
  - A. There could be one out of several likely causes, some of which are, broken wire-loose connection, bell out of adjustment, wires grounded, wires shorted, etc. The whole signal arrangement should have a complete examination by a competent electrician at frequent intervals.
7. Q. (a) What dangers to life arise from the use of electricity in and around coal mines? (b) What precautions would you take to prevent accidents from contact with the electrical equipment?
  - A. (a) The chief dangers are that of men or animals coming into contact with live wires, igniting gas, or igniting waste of oil or other combustible materials, etc. (b) Safety mats should be used in front of all switch boards, signs marked dangerous should be displayed at all likely places where a man could come in touch with the live wires. It is a good plan to keep a good pair of rubber gloves ready when it is necessary to repair or examine any electrical parts or machinery.
8. Q. How could you test the safety catches on the cage?
  - A. The safety catches on a cage used for hoisting or lowering men, should be carefully examined each morning, before starting to hoist also at mid-day, or at the beginning of each shift and in the middle of the shift. One way that the safety catches could be efficiently tested is as follows: Raise the cage as high as possible, stout timbers of sufficient size to hold the cage are then placed across the shaft, the rope then could be cut, and if the catches did not hold the timbers would stop the cage. The general method of inspection the catches is to examine them thoroughly and look at the guides at the bottom, where the safety catches are when the cage is on the bottom. If the safeties are operating, there would be the prints of them in the guides, if wooden guides are used, but if steel guides are used the safety catches should grab hold of the guides when the cage rests on the bottom and the hoisting rope is slack.
9. Q. How would you examine a hoisting rope?
  - A. I would instruct the engineer to run the hoist slowly, and stand near the rope, holding a piece of soft wood against the rope, thereby watching and feeling for loose or broken wires or strands in the rope. Should the rope be badly worn, have loose or broken wires or strands, or be abnormally stretched, it should be discarded. Hoisting ropes stretch some when first put in use, then when they have become worn, they again begin to stretch and their reliability or safeness is about at an end.

NOTE: All or nearly all rope companies have special brands or trade names for their own ropes, which they claim are superior to any other make. But the above constants or breaking strains for a one inch rope is the standard in use for working all rope problems.

10. Q. In what way is an electrical hoist different from a steam hoist?
- A. An electric hoist is operated by an electric motor, while a steam hoist is operated by a steam engine.

## LESSON NO.7

1. Q. What is a Horsepower, and what is its electrical equivalent?

A. A horsepower is the energy or work that is required to raise a weight of 33,000 pounds, 1 ft. in height in 1 minute of time, or a weight of 330 lbs., 100ft. high in 1 minute of time, or in other words, this is equal to 33,000 ft. pounds. Electrically, it takes 746 watts to do the work of the above or 33,000 ft. lbs. of work. The one horsepower is equal to 746 watts.
2. Q. What is the purpose of a fly-wheel? What is the effect if the fly-wheel is too light for its work? If it is too heavy?

A. The purpose of a fly-wheel on an engine is to carry the engine over the center and steady the engine while running by taking up power in the middle of the stroke and giving it out at the end of the stroke. If the fly-wheel is too heavy it makes the engine harder to handle, causing a heavier load on the engine than necessary and absorbs more power than a fly-wheel should in acceleration of the load, also while starting and stopping the load.
3. Q. Name a perfect conductor, also name a perfect non-conductor.

A. There are no perfect conductors neither are there any perfect non-conductors.
4. Q. What is the practical working difference between a dynamo and an electric motor, in their use with electric power?

A. A dynamo is a machine for converting mechanical energy into electrical energy. A motor on the other hand, is a machine or device used for converting electrical energy into mechanical energy.
5. Q. Have you ever observed a motor start up in one direction and then reverse itself? Explain what would cause this to happen.

A. When a compound motor is started under no load, the shunt circuit naturally takes the larger current and if, through a faulty connection it happens that the shunt and series fields are bucking each other, the motor will start to rotate in a direction determined by the shunt current, which for a time predominates, but when the motor

takes its load, the major current will flow through the series current, with the result that the direction will be reversed.

6. Q. How much work is being done in raising 300 tons of coal up an incline 2700 feet in length and rising 1 ft. in 3 ft.? Add 40% for friction of the load.
  - A. Three hundred tons equals 600,000 lbs. of coal. Incline 2700 ft. long, rising 1 ft. in 3 equals 2700 divided by 3 equals 900 feet vertical rise.  $600,000 \times 900$  equals 540,000,000 ft. lbs. in hoisting the coal, but we have to add 40 for the friction of the road, ropes, engine, etc. So  $540,000,000 \times 40$  equals 216,000,000 ft. lbs. So we have a total of 540,000,000 plus 216,000,000 equals 756,000,000 ft. lbs. of work done. In explanation will say, regardless of the incline of the slope or hoist, we only raise the load up the vertical height of the lift, so in the 2700 ft. incline, with a rise of 1 in 3, we have 2700 divided by 3 equals 900 ft. for the vertical lift. This answer gives the amount of work done in raising the coal alone, allowing 40% for friction and supposedly taking care of the weight of the cars and rope.
7. Q. What is the law in reference to fastening ropes to drums and cages?
  - A. The rope shall be securely fastened to the drum, with at least 3 laps remaining on the drum, when the cage is at the bottom or the rope is lowered to the lowest point in the slope. The other end shall be securely fastened with suitable sockets or clamps and chains.
8. Q. How often should a hoisting rope be cut off and re-socketed?
  - A. Where the hoisting rope is socketed at the cage, the socket must be cut off and re-socketed at least once each six months.
9. Q. Why does a pump lift water from its suction end?
  - A. The reason that a lifting pump will lift water is because when actuating the pump plunger, it tends to create a vacuum, or partial vacuum, when the atmospheric pressure or the pressure of the air on the earth, forces the water into the vacuum formed in the pump.
10. Q. Is the vertical distance that a pump will draw water affected by its elevation above sea level? Why?
  - A. The above refers to a pump at sea level. The distance above or below sea level controls the distance that a suction pump will raise water. The higher above sea level a pump is located the less water will it pump. Everything else being the same, as if a pump of same type and condition, being used below sea level would pump a much larger amount of water, for the following reason: The weight of air on the surface of the earth at sea level is approximately 15lbs. per sq. inch. This pressure is what tends to force the water up through the pump when the plunger is worked up and down, causing a partial vacuum in the pump.

The high above sea level the pump is located the less atmospheric pressure there is to raise the water, also the lower below sea level the pump is located the more or higher air pressure we have on the water, so the high it will raise water in the pump.

## LESSON NO. 8

1. Q. What is the daily output of a mine under the following conditions: 8 hr. hoisting time, each dump 5200 lbs. The time required per hoist is 50 seconds, changing cars is 22 seconds.  
A. The time per hoist would be 50 divided 22 equals 72 seconds per hoist, allowing nothing for delays during the day of 8 hours. We would have  $8 \times 60 \times 60$  which equals 28,800 seconds, then 72 seconds for each hoist. We have 28,800 divided by 72 equals 400 hoist per day of 8 hours. Then 5200 lbs. of coal per hoist,  $400 \times 5200$  equals 2,080,000 lbs. of coal hoisted, then 2,080,000 divided by 2,000 equals 1,040 tons of coal per day.
2. Q. Why is it the general practice to carry a high voltage on power lines?  
A. It is much more economical to carry high voltage electricity over long power lines, because the higher the voltage, the lower the line loss of voltage.
3. Q. (a) What would be the current required for a motor of 25 H.P. at a pressure of 500 volts? (b) A motor is taking 45 amperes at a pressure of 500 volts. What is the H.P.?  
A. Volts x amps equal watts. Also 746 watts equals 1 H.P. So we have watts divided by Volts equal Amperes.  $25 \times 746$  equals 18,650 watts, then 18,650 divided by 500 equals 37 amp. (b) We have  $45 \times 500$  equals 22,500 watts, 22,500 divided by 746 equals 30 plus H.P.
4. Q. Why is direct current used in preference to alternating current in a mine operation?  
A. A wide range of speeds may be obtained without undue loss of energy or power. Also suitable A.C. motors have, so far, not been a success for mine locomotives.
5. Q. What is the effect on motors of a drop in voltage?  
A. Inefficient operation, abnormal heating, possible burn outs and decreased speed.
6. Q. How can excessive line loss be avoided?  
A. By ample current carrying capacity of the conductors, in other words, wire of plenty large size for the current needed, by good bonding also by locating the generator sets near place where current is to be used.
7. Q. How is electricity conducted into mines?  
A. By means of ample sized conductors, usually made of copper.
8. Q. What protective devices should be installed on all power lines entering the mine?  
A. Properly grounded lightning arresters and circuit breakers.
9. Q. How should electric conductors on branch circuits be protected against overloads?

- A. By fuses or suitable overload devices, such as an automatic circuit breaker.
10. Q. What are the dangers connected with electric transmission in mines?
- A. Electric shock dangers, also fires and explosions from short circuits, etc.

## LESSON NO. 8

1. Q. What is the daily output of a mine under the following conditions: 8 hr. hoisting time, each dump 5200 lbs. The time required per hoist is 50 seconds, changing cars is 22 seconds.
- A. The time per hoist would be 50 divided by 22 equals 72 seconds per hoist, allowing nothing for delays during the day of 8 hours. We would have  $8 \times 60 \times 60$  which equals 28,800 seconds, then 72 seconds for each hoist. We have 28,800 divided by 72 equals 400 hoist per day of 8 hours. Then 5200 lbs. of coal per hoist,  $400 \times 5200$  equals 2,080,000 lbs. of coal hoisted, then 2,080,000 divided by 2,000 equals 1,040 tons of coal per day.
2. Q. Why is it the general practice to carry a high voltage on power lines?
- A. It is much more economical to carry high voltage electricity over long power lines, because the higher the voltage, the lower the line loss of voltage.
3. Q. (a) What would be the current required for a motor of 25 H.P. at a pressure of 500 volts? (b) A motor is taking 45 amperes at a pressure of 500 volts. What is the H.P.?
- A. Volts x amps equals watts. Also 746 watts equals 1 H.P. So we have watts divided by Volts equal Amperes.  $25 \times 746$  equals 18,650 watts, then 18,650 divided by 500 equals 37 amp. (b) We have  $45 \times 500$  equals 22,500 watts, 22,500 divided by 746 equals 30 plus H.P.
4. Q. Why is direct current used in preference to alternating current in mine operation?
- A. A wide range of speeds may be obtained without undue loss of energy or power. Also suitable A.C. motors have, so far, not been a success for mine locomotives.
5. Q. What is the effect on motors of a drop in voltage?
- A. Inefficient operation, abnormal heating, possible burn outs and decreased speed.
6. Q. How can excessive line loss be avoided?
- A. By ample current carrying capacity of the conductors, in other words, wire of plenty large size for the current needed, by good bonding also by locating the generator sets near place where current is to be used.
7. Q. How is electricity conducted into mines?
- A. By means of amply sized conductors, usually made of copper.
8. Q. What protective devices should be installed on all power lines entering the mine?
- A. Properly grounded lightning arresters and circuit breakers.
9. Q. How should electric conductors on branch circuits be protected against overloads?



- A. By fuses or suitable overload devices, such as an automatic circuit breaker.
- 10. Q. What are the dangers connected with electric transmission in mines?
  - A. Electric shock dangers, also fires and explosions from short circuits, etc.

## LESSON NO. 9

1. Q. What is the disadvantage of D.C. Current?
  - A. The comparative low voltage used in mines can be used economically only within a limited distance from its source of generation.
2. Q. What is the effect of distance upon D.C. voltage?
  - A. The voltage is decreased by line drop due to the resistance of the conductors. The larger the wires the less resistance for any certain amount of voltage.
3. Q. What are some advantages of A.C. Electricity?
  - A. Alternating current permits transmission at high-voltage with little line loss and is easily reduced in voltage at or near the place where it is to be used.
4. Q. What is the cause of abnormal heating of conductors?
  - A. Caused by using too small a conductor or wire, poor connections, poor bonding, low voltage or overloading the motor according to the size of the conductors, generally the wiring.
5. Q. How should electrical equipment be protected against overloads?
  - A. By relays or by circuit breakers, properly set to guard against overloads.
6. Q. From a safety standpoint, what should be the maximum voltage used on trolley wire or other exposed electrical conductors in mines?
  - A. The Illinois Mining Laws forbids more than 275 volts to be carried on such conductors.
7. Q. what precautions should be taken before a cable or electric device is repaired?
  - A. A person should be sure the power is cut off, before starting on the ob. It is also a good practice to "block-out" switches in the "off" position while repairs are being made so that the electricity cannot be put on by anyone by mistake while repairs are being made.
8. Q. What type of power wire should be used to serve stationary electrical equipment?
  - A. Wire of ample size, and well insulated, by rubber or equal insulation.
9. Q. How may persons be protected from short circuits in electrical machinery?
  - A. By grounding the frame or casing.
10. Q. What type of disconnectors should be used with all electrical machinery?
  - A. Switches, covered to protect the operator against arcs.
11. Q. What type of fuse should be used?
  - A. Enclosed fuses or fuse boxes should be used in order to protect the operator against arcs, when opening or closing the switches.

12. Q. What type of fuse should not be used?

A. An open fuse should never be used, because it may cause an arc, burning or blinding the operator.

## LESSON NO. 10

1. Q. How should employees be protected from contact with electrical equipment, control and switchboard installations?

A. By adequate fencing or guards around the machinery, and with rubber mats or insulated platforms in front of all switch boards and panels.

2. Q. (a) What is electrolysis? (b) What is the effect of electrolysis? (c) How can electrolysis be prevented?

A. (a) The action of an electric current which carries away the particles of an electric current. (b) It disintegrates metal subjected to its action and breaks down water to oxygen and hydrogen. (c) Electrolysis can be prevented by effective or good bonding and grounding.

3. Q. What provision should be made relative to the possible danger from spilled oil from transformers and switches?

A. Means should be taken to prevent any spilled oil from escaping from the station.

4. Q. What is the effect of a continued overload or under voltage on operating motors?

A. The motor will become heated and thereby the insulation on the wiring will be destroyed.

5. Q. What is the unit by which electricity is paid?

A. Electric energy or current is paid for by kilowatt hours. (K.W.H.) The kilowatts used over any period of time calculated to an hour basis.

6. Q. If the cost of D.C. energy or current is 2 cents per K.W.H., what is the charge on a motor operating at 40 amperes on 250 volts for 100 hours?

A. We have 40 amps on 250 volts for 100 hrs. Then 1 K.W. equals watts. Also amps x volts equal watts. Then we have  $(40 \times 250 \times 100) / 1000$  equal 1,000 K.W.H.

7. Q. (a) What instrument is used in measuring amperes? (b) What instrument is used in measuring voltage? (c) What instrument is used in measuring watt hours?

A. (a) Ammeter (b) Voltmeter (c) A watt hour meter.

8. Q. How many K.W. are used to develop 50 H.P.?

A. One H.P. equals 746 watts, also 1000 watts equal 1 K.W. then we have in  $50 \text{ H.P.} \times 746$  equal 37,300 watts. Then 37,300 watts divided by 1000 equal 37.3 K.W.

9. Q. What is the carrying capacity in amperes of a 0000 copper wire?

A. The carrying capacity of a 0000 copper wire is about 320 amperes.

10. Q. We wish to install a pump, which it is estimated will take 23 H.P. to drive. What size of motor would you install and size of wire to motor, the dynamo being 1500 yards from the location of the pump.

A. I would install a motor of not less than 25 H.P. and use 000 wire.

11. Q. What are the three classes of direct current motors in reference to their windings?

A. The 3 classes of windings are compounds, shunt, and series. Be sure to get an electrician to show you a motor of each of these types and explain the differences.